



### LG Electronics

<http://www.lg.com/global/business>  
<http://partner.lge.com/global>  
<http://blog.lghvacstory.com/>

Distributed by

LG Smart Inverter COMMERCIAL AIR CONDITIONERS | FOR MIDDLE EAST & AFRICA



## LG Smart Inverter

# COMMERCIAL AIR CONDITIONERS

FOR MIDDLE EAST & AFRICA



# CONTENTS

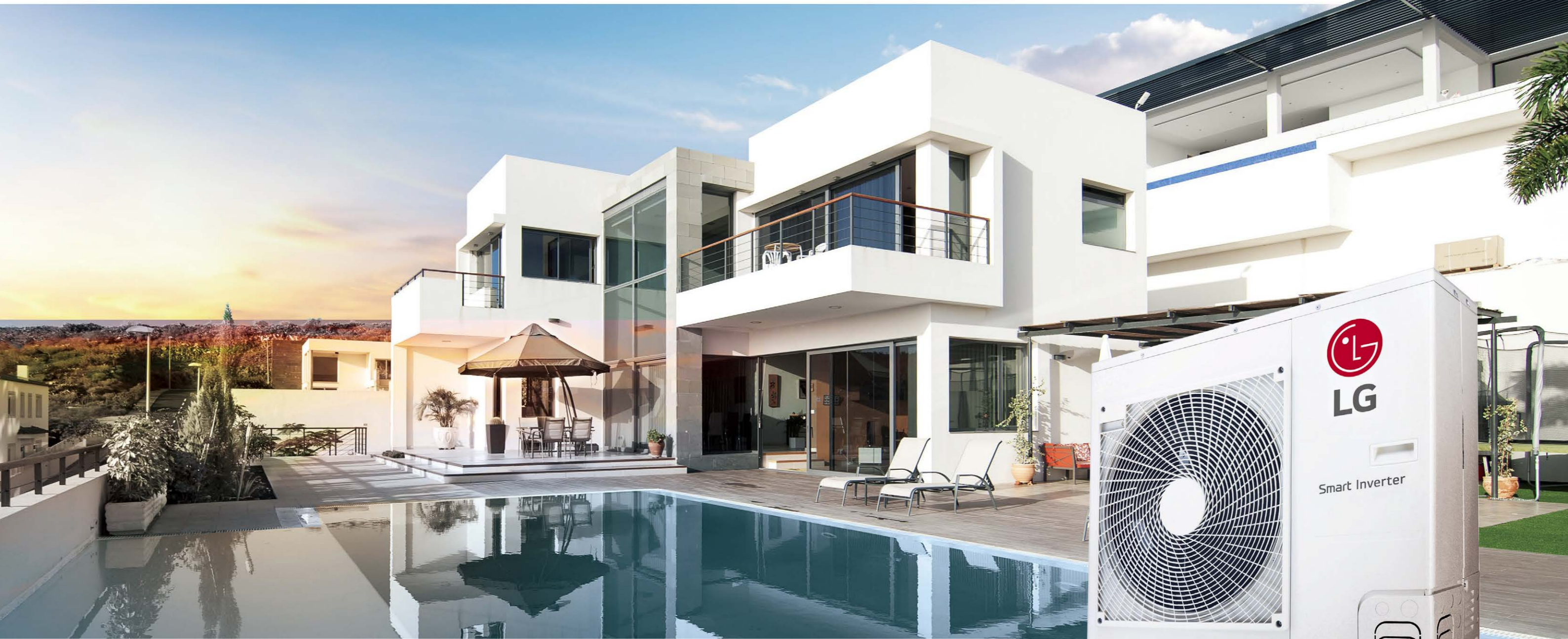

Application Solutions .....	04
Why LG Smart Inverter? .....	06
LG Inverter Single Split .....	10
The Evolution of LG Technology .....	12
LG Technology Fan .....	14
Line-Up .....	16
Core benefit of LG Smart Inverter Single Split .....	22

• Energy Saving • Comfort • Reliability • Convenience

LG Smart Inverter Single Split .....	32
Ceiling Mounted Cassette .....	34
Ceiling Concealed Duct .....	46
Ceiling Suspended Unit .....	58
Floor Standing Unit .....	66
Single Package .....	72
LG Control Solutions .....	82
Individual Control .....	84
LG HVAC Control Line-Up .....	90

# APPLICATION SOLUTIONS

 Ducted
  Single Package

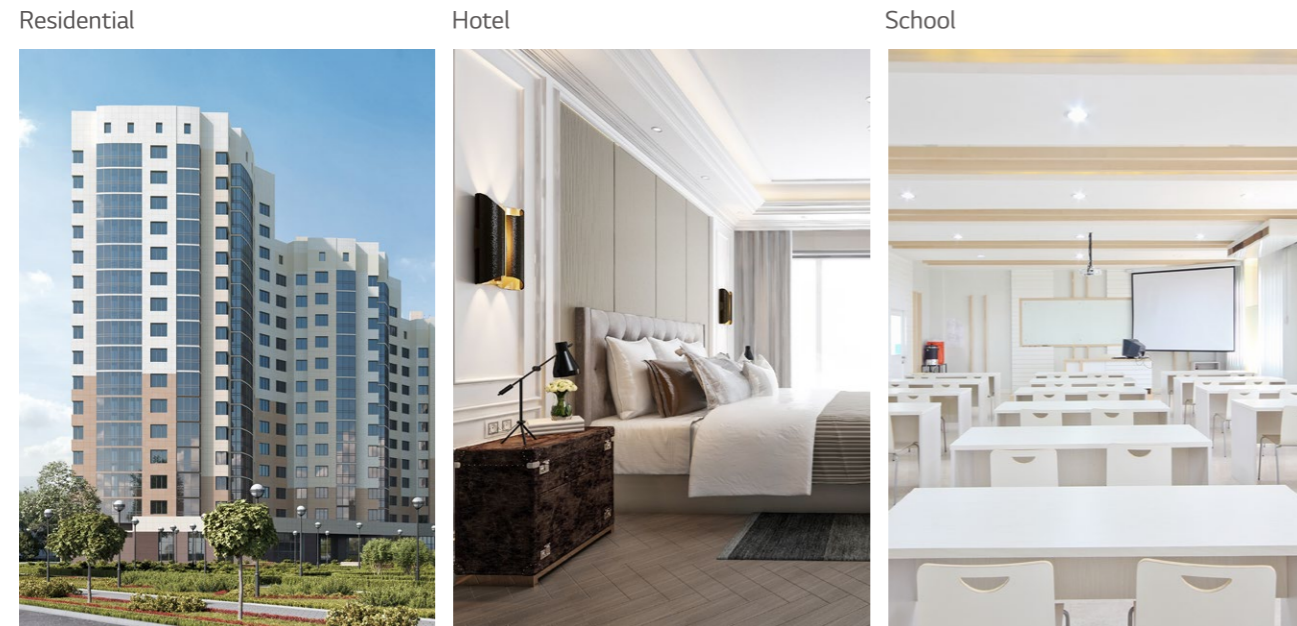

 Cassette

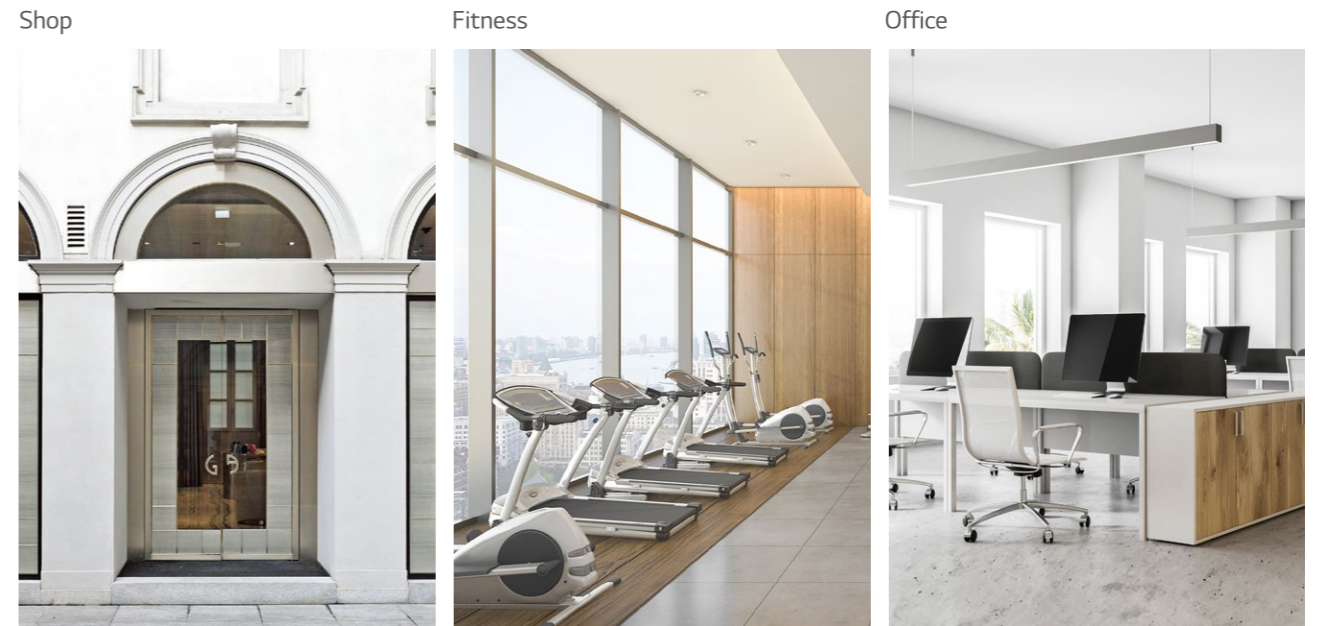

 Ceiling Suspended

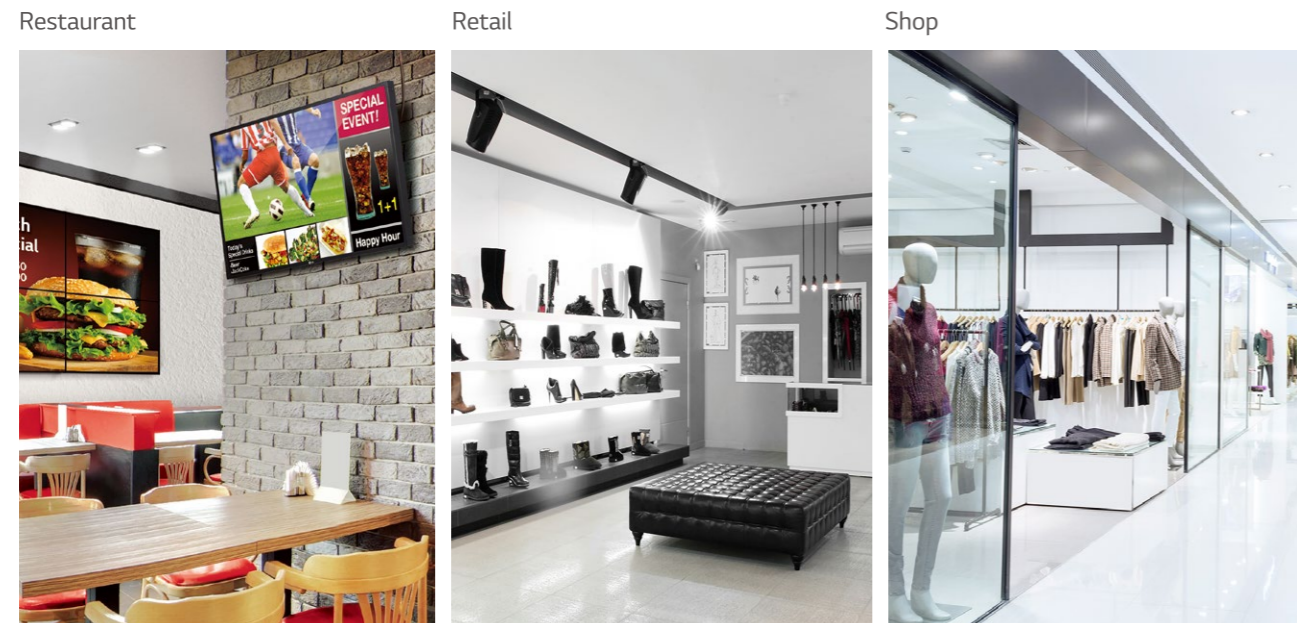

 Floor Standing

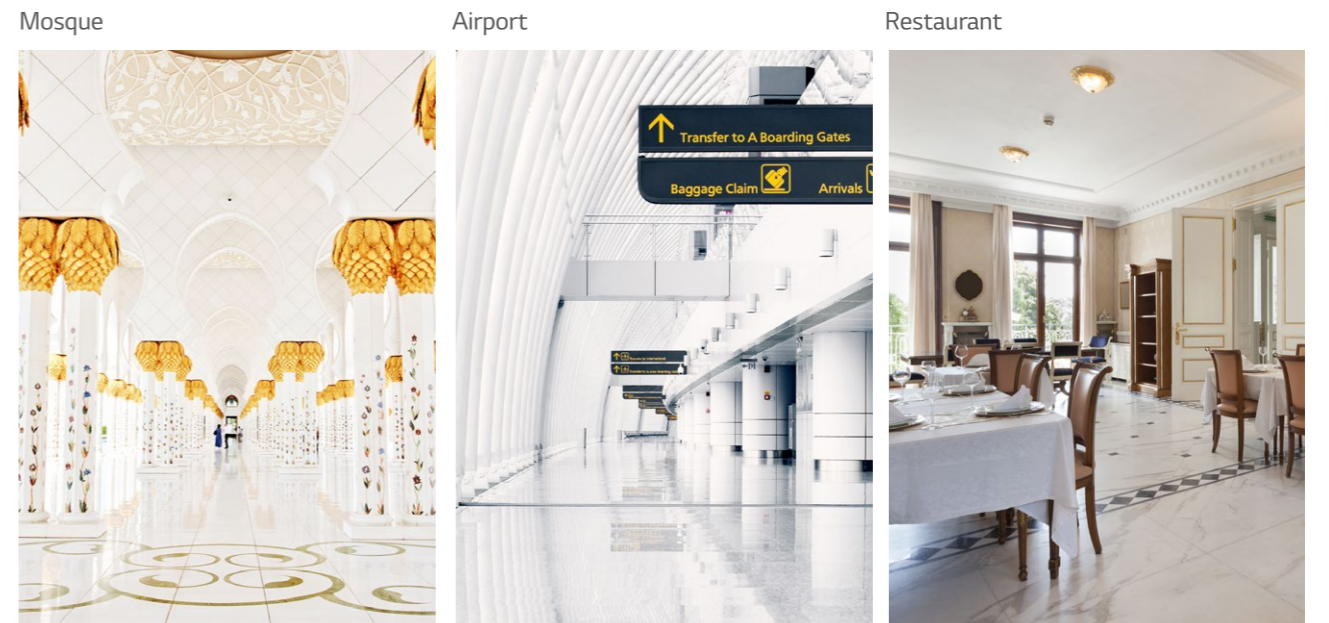



# WHY LG SMART INVERTER?

LG Inverter technology is applied to various electronics including refrigerators and washing machines which continuously draw global attention. The best quality is the excellent level of technology provided by LG, a reputable electronic provider. LG is also known for its comprehensive HVAC provider. LG's latest Smart Inverter Single Split solutions are all equipped with the company's advanced Smart Inverter Technology.

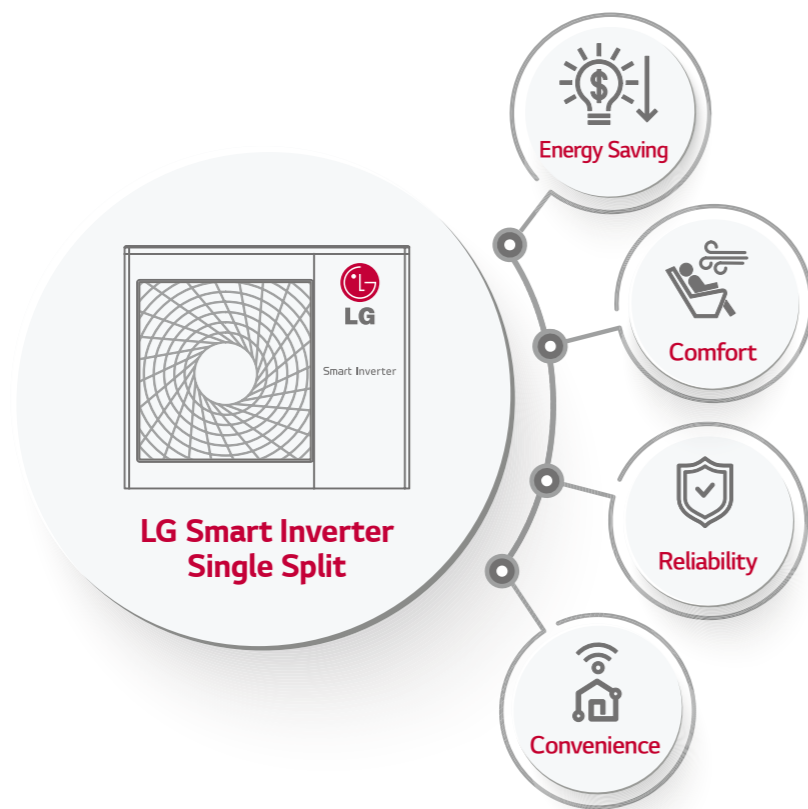

※ Specifications may vary for each model.

## ENERGY SAVING



### Comfort Cooling with Humidity Sensor

Comfort cooling is a energy saving function that changes evaporation temperature in accordance with temperature & humidity.



### Human Detection Sensor

Automatic direction of air flow & operation by sensing human body.



### Quick Cooling

At the same condition, the inverter reaches the set temperature about 30% faster than the constant speed.

## COMFORT



### Low Noise

Inverter makes lower noise than constant speed due to adjustable frequency according to the load.

## RELIABILITY



### High and Low Voltage Protection

Below low voltage limit, inverter compressor reduces frequency(Hz) and boost DC voltage, over high voltage limit, cuts off the relay to prevent damage of DC capacitor.



### Corrosion Resistant Heat Exchanger

The fin of heat exchanger covered with gold-colored special coating prevents corrosion, extending the lifespan of the unit.

## CONVENIENCE



### ThinQ

Control your air conditioners via using the smart internet devices such as Android or iOS based smartphones. This advanced technology provides you the best convenience.



### Simple Test Run Via LGMV

Fast and accurate auto test run can be executed and the professional installer running the test can receive test results via email, which shortens installation hours and increases overall efficiency in installation processes.

# WHY LG SMART INVERTER

## COMFORTABLE OPERATION

Once the desired temperature is achieved, unlike conventional air conditioners that turn the compressor on and off, LG inverter units adjust and constantly vary the compressor speed to maintain the desired temperature with minimal fluctuation to ensure that your comfort is not compromised.

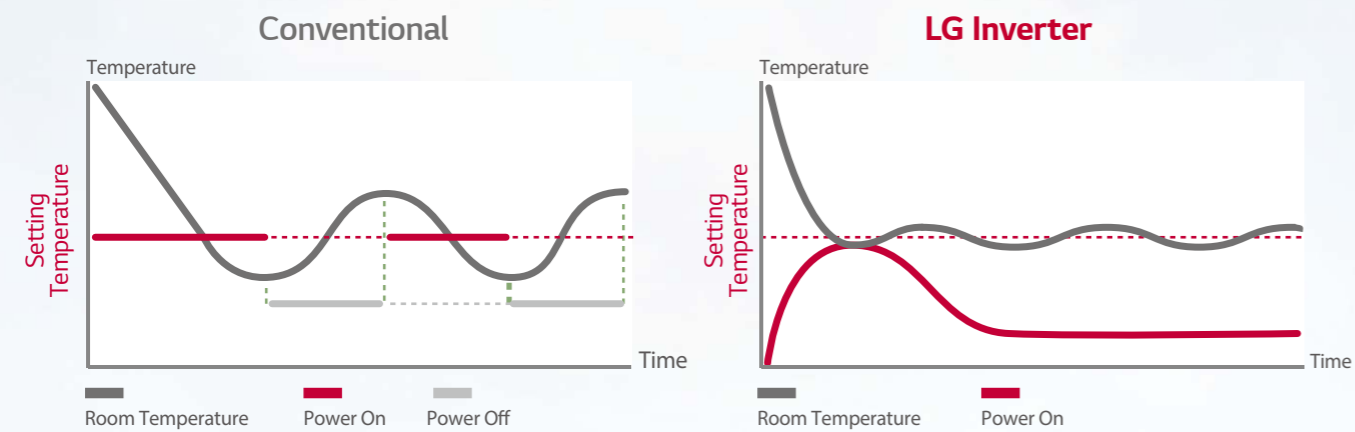

**Recognizing** the importance of saving energy, LG has taken the initiative to develop new and, more efficient inverter technology. In addition to consuming less electricity, the company's advanced inverter systems also boast powerful performance and enhanced reliability.

**LG's Inverter** Single Split lowers energy usage and operational costs, illustrating how smart technology can make a real difference. New model, designed for commercial spaces such as offices and retail stores, can operate for extended periods of time, while providing exceptional energy efficiency.

**The Inverter** Single Split is able to produce an impressive volume of cool air, helping to create the perfect indoor temperature quickly, as well as delivering fast and efficient cooling. LG's latest solution can also minimize electricity consumption.



# LG INVERTER SINGLE SPLIT

LG's Inverter Single Split lowers energy usage and operational costs, illustrating how smart technology can make a real difference. New model, designed for commercial spaces such as offices and retail stores, can operate for extended periods of time, while providing exceptional energy efficiency.

### Public Facilities (Restaurants, Fitness centers, Conference rooms)

LG Smart Inverter system offers optimal independent air conditioning for large spaces that require an ideal temperature, supply of fresh air, and individual control.

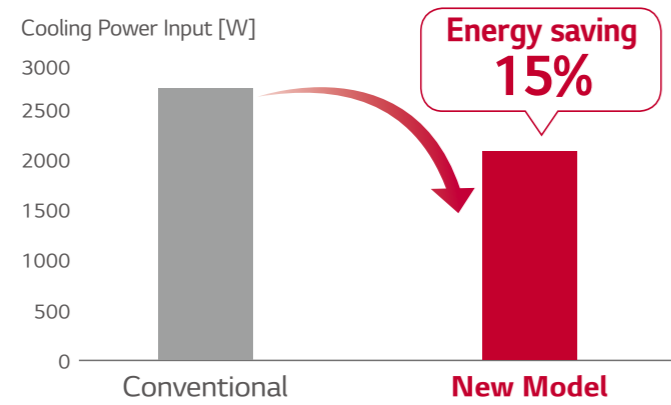

• CEILING SUSPENDED

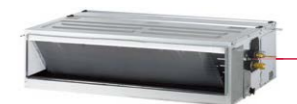

• CEILING CONCEALED DUCT



red dot design award  
※ New Panel : PT-MCHWO

• 4 WAY CASSETTE



• FLOOR STANDING

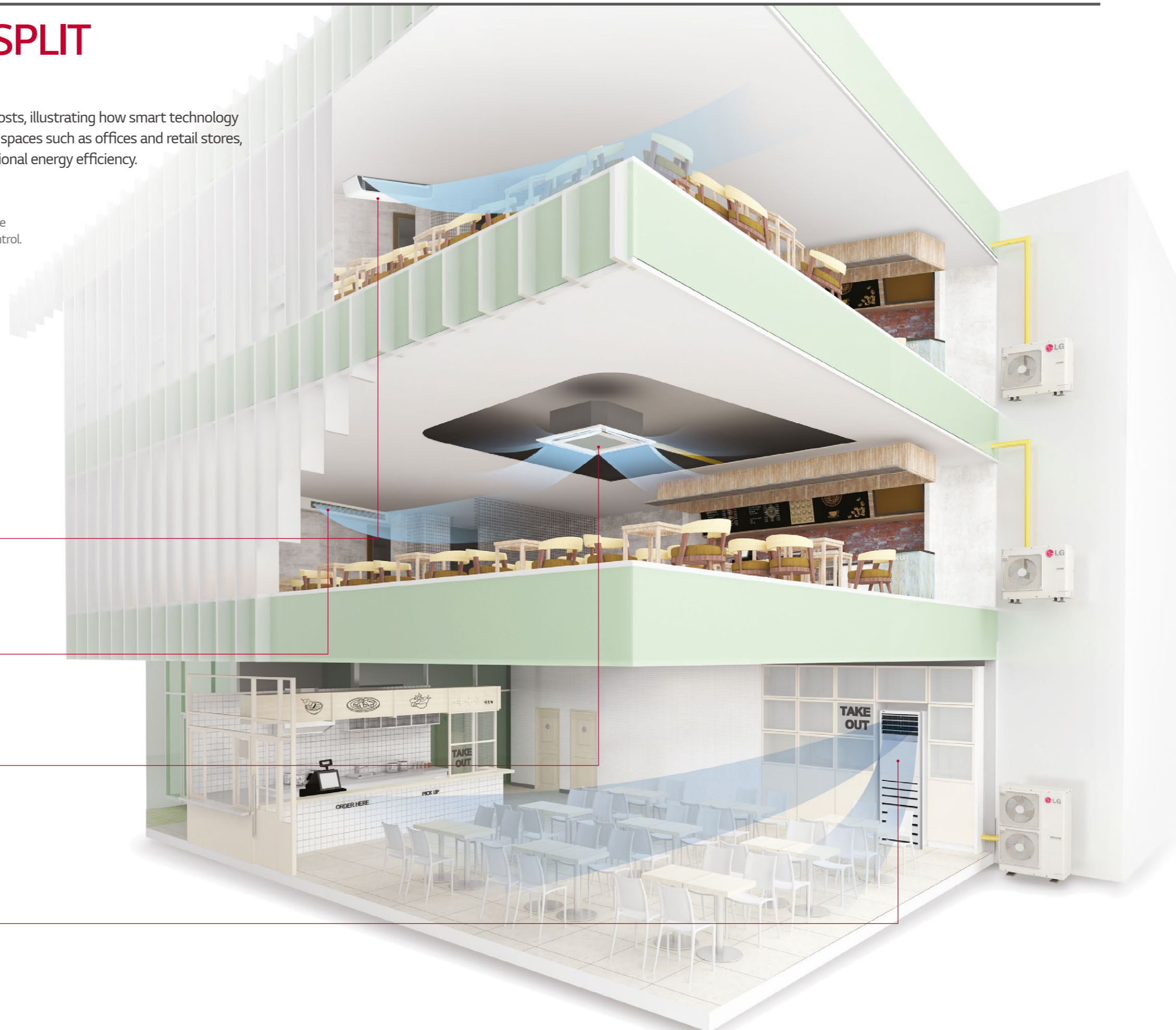

# THE EVOLUTION OF LG TECHNOLOGY

## REVOLUTIONARY SCROLL COMPRESSOR

Revolutionary scroll compressor is applied for high-efficiency and reliability. This type of compressor is more advanced compared to the conventional one. Especially tilting motion of scroll has been improved. Further, the operation range is improved compared to the conventional type.

### R1 Compressor™



- Extended Operation Range (max 150Hz)
- High Efficiency (low load at low speed / total efficiency)
- Low Noise (high speed possible)
- 20% Weight Reduction (vs. conventional compressor)
- Scroll Compressor with Simple Structure
- Improved Tilting Motion of Scroll

#### POWER

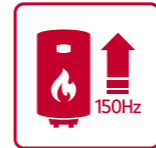

**Higher Performance**  
Extended Operation Range (max 150Hz)

#### DURABILITY

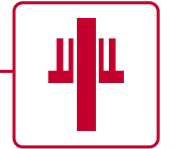

**Solid compressor operation** assuring higher durability  
Shaft-through Structure & Support both ends of shaft

#### SILENCE



**Lower Noise & Vibration**  
- Max 4 dB(A) ↓  
- Less Weight (\*\*20% ↓)  
- Superior Reliability  
- Bottom compression & simple structure

#### EFFICIENCY



**Higher Energy Efficiency** (\*SEER 20% ↑)  
Centrifugal oil return & Oil separating guide for oil discharge reduction

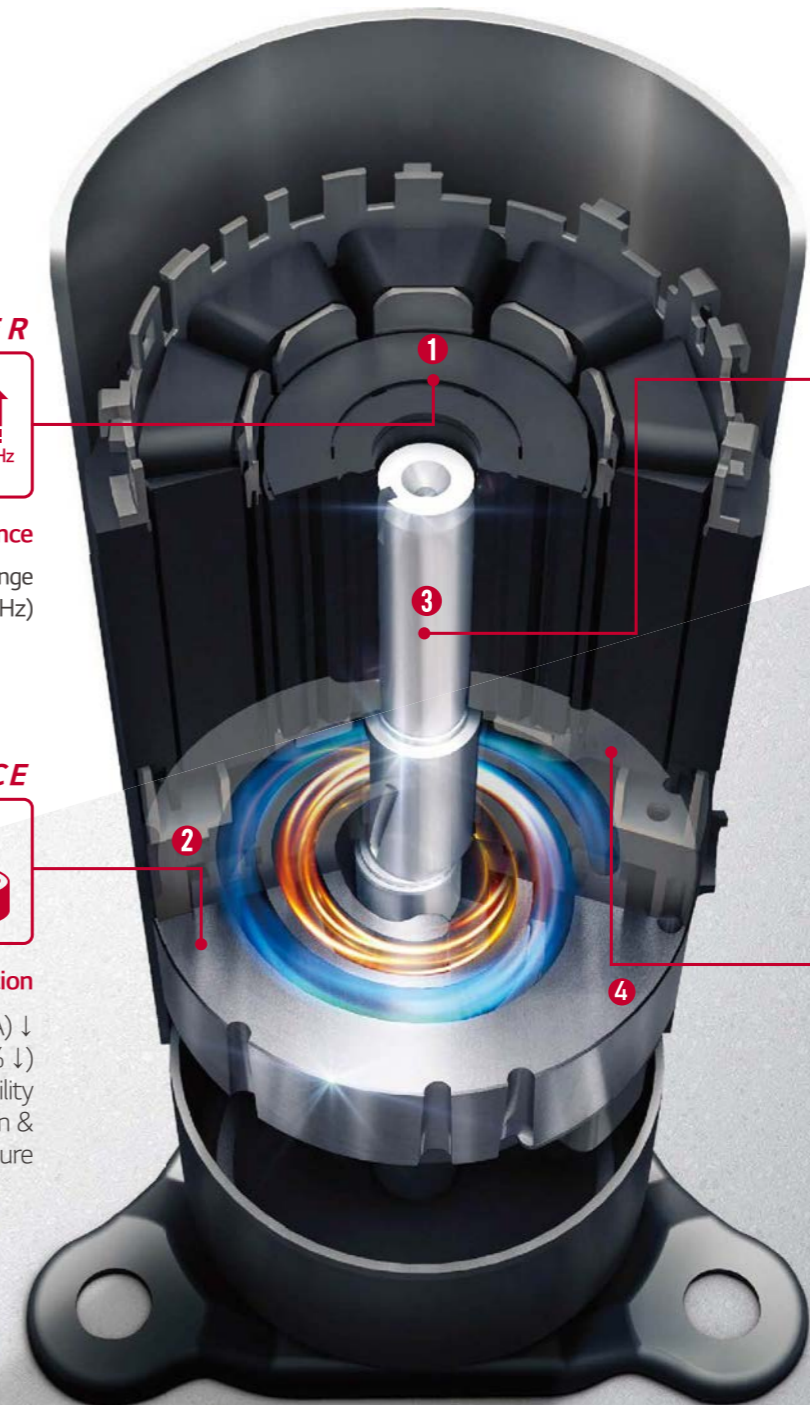

## R1 Compressor™

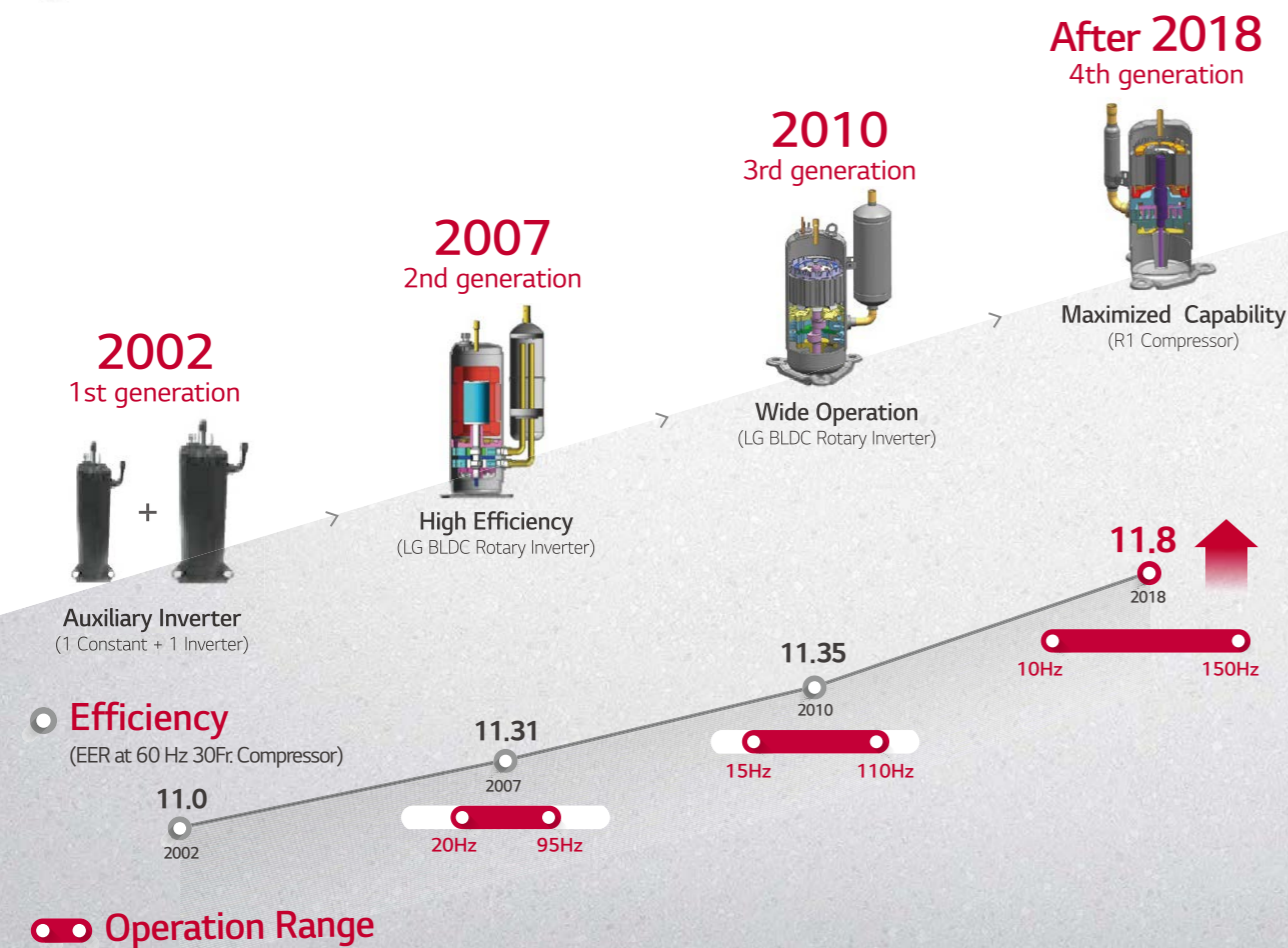

※ All the contents in this material is based on LG single split model.

\* LG Internal test result, Based on single split 10 kW Cassette  
\*\* LG Internal test result, Based on conventional compressor (Rotary type GPT442M)

# LG TECHNOLOGY FAN

## \*OUTDOOR FAN (BIOMIMETIC FAN)

Newly developed fan, designed by biomimetic shape, blows higher air volume and noise is reduced accordingly.

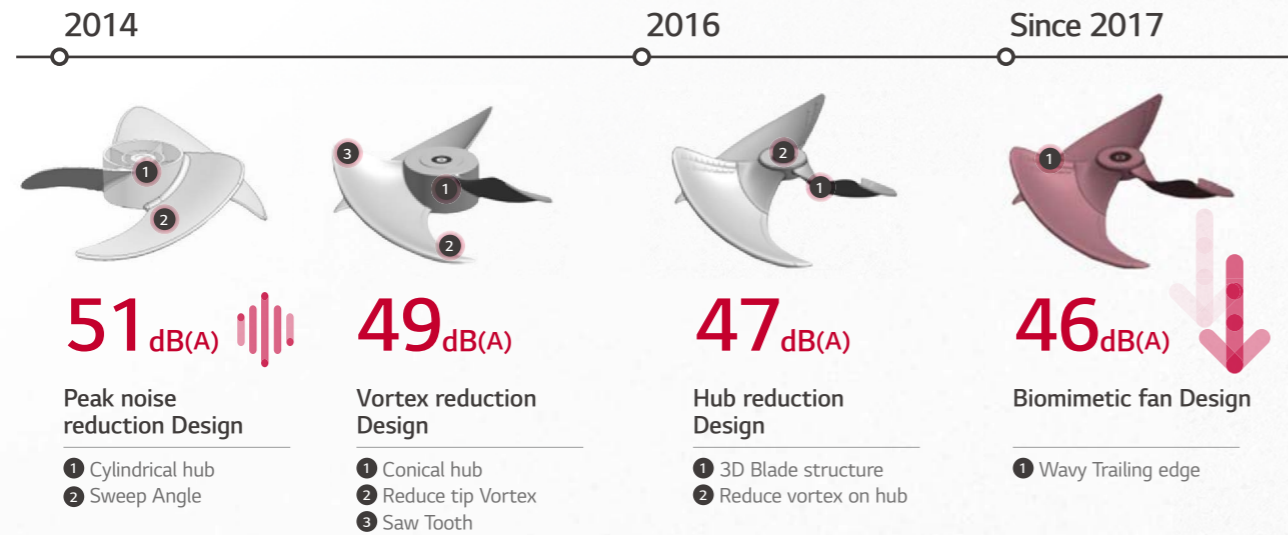

## INDOOR FAN

Quiet and powerful indoor unit fan through years of fluid dynamic design and manufacturing knowhow.

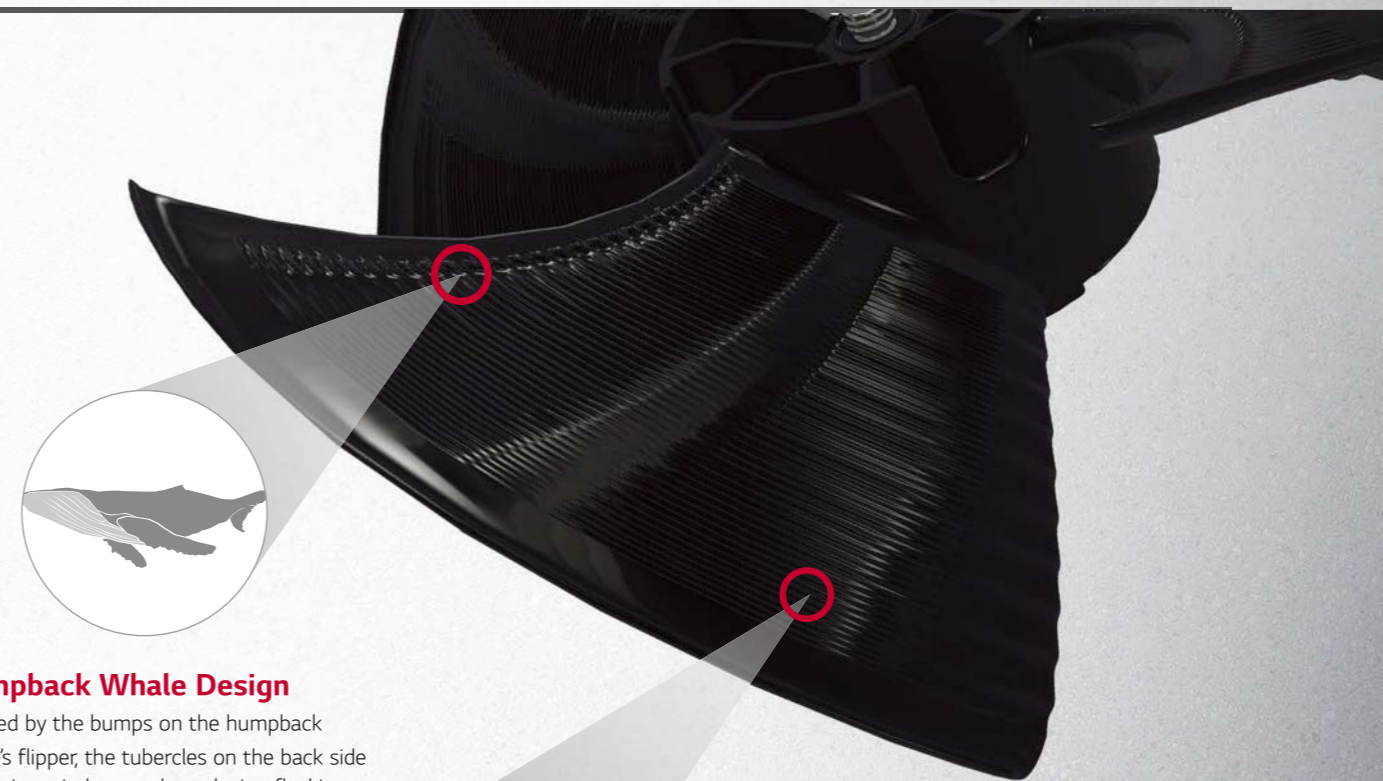
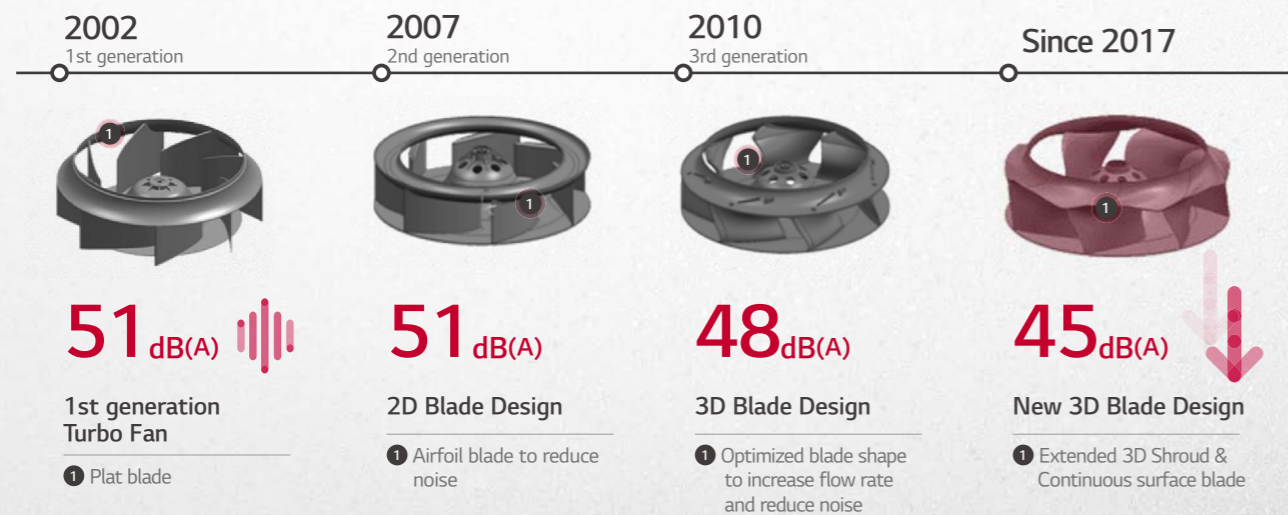

### Humpback Whale Design

Inspired by the bumps on the humpback whale's flipper, the tubercles on the back side increasing wind power by reducing flapping.



### Clam Shell Pattern

Like the clam shell textures, the range difference created by moire pattern reducing noise level.



\* All the contents in this material is based on LG single split model.





# PRODUCT LINE-UP

## HIGH EFFICIENCY

### TROPICAL HEAT

#### CEILING CASSETTE

						
<b>kBtu / kW</b>	<b>18 / 5.3</b>	<b>24 / 7.0</b>	<b>30 / 8.8</b>	<b>36 / 10.6</b>	<b>48 / 14.1</b>	<b>54 / 15.8</b>
Indoor Model Name	ATNW18GPLT1	ATNW24GPLT1	ATNW30GPLT1	ATNW36GNLT1	ATNW48GMLT1	ATNW54GMLT1
Outdoor Model Name	ATUW18GPLT1	ATUW24GPLT1	ATUW30GPLT1	ATUW36GNLT1	ATUW48GMLT1	ATUW54GMLT1





#### CEILING CONCEALED DUCT (MIDDLE STATIC)

						
<b>kBtu / kW</b>	<b>18 / 5.3</b>	<b>24 / 7.0</b>	<b>30 / 8.8</b>	<b>36 / 10.6</b>	<b>48 / 14.1</b>	<b>54 / 15.8</b>
Indoor Model Name	ABNW18GM1T1	ABNW24GM1T1	ABNW30GM1T1	ABNW36GM3T1	ABNW48GM3T1	ABNW54GM3T1
Outdoor Model Name	ABUW18GM1T1	ABUW24GM1T1	ABUW30GM1T1	ABUW36GM3T1	ABUW48GM3T1	ABUW54GM3T1

#### CEILING SUSPENDED

						
<b>kBtu / kW</b>	<b>18 / 5.3</b>	<b>24 / 7.0</b>	<b>30 / 8.8</b>	<b>36 / 10.6</b>	<b>48 / 14.1</b>	<b>54 / 15.8</b>
Indoor Model Name	AVNW18GM1T1	AVNW24GM1T1	AVNW30GM1T1	AVNW36GM2T1	AVNW48GM2T1	AVNW54GM2T1
Outdoor Model Name	AVUW18GM1T1	AVUW24GM1T1	AVUW30GM1T1	AVUW36GM2T1	AVUW48GM2T1	AVUW54GM2T1

#### FLOOR STANDING

						
<b>kBtu / kW</b>				<b>36 / 10.6</b>	<b>48 / 14.1</b>	<b>96 / 28.2</b>
Indoor Model Name				APNW36GT3S1	APNW50*T3E0	APNW100LFT0
Outdoor Model Name				APUW36GT3S1	APUW50*T3E0	APUW100LFT0

#### SINGLE PACKAGE

<b>Capacity (RT)</b>				<b>20, 25 RT</b>
Single Package				
Model Name				AK-W240LC00 AK-W300LC00

### TROPICAL COOL

#### CEILING CASSETTE

						
<b>kBtu / kW</b>	<b>18 / 5.3</b>	<b>24 / 7.0</b>	<b>30 / 8.8</b>	<b>36 / 10.6</b>	<b>48 / 14.1</b>	<b>54 / 15.8</b>
Indoor Model Name	ATNQ18GPLT1	ATNQ24GPLT1	ATNQ30GPLT1	ATNQ36GNLT1	ATNQ48GMLT1	ATNQ54GMLT1
Outdoor Model Name	ATUQ18GPLT1	ATUQ24GPLT1	ATUQ30GPLT1	ATUQ36GNLT1	ATUQ48GMLT1	ATUQ54GMLT1



#### CEILING CONCEALED DUCT (MIDDLE STATIC)

						
<b>kBtu / kW</b>	<b>18 / 5.3</b>	<b>24 / 7.0</b>	<b>30 / 8.8</b>	<b>36 / 10.6</b>	<b>48 / 14.1</b>	<b>54 / 15.8</b>
Indoor Model Name	ABNQ18GM1T1	ABNQ24GM1T1	ABNQ30GM1T1	ABNQ36GM3T1	ABNQ48GM3T1 ABNQ48LM3T0	ABNQ54GM3T1 ABNQ54LM3T0
Outdoor Model Name	ABUQ18GM1T1	ABUQ24GM1T1	ABUQ30GM1T1	ABUQ36GM3T1	ABUQ48GM3T1 ABUQ48LM3T0	ABUQ54GM3T1 ABUQ54LM3T0

#### CEILING SUSPENDED

						
<b>kBtu / kW</b>	<b>18 / 5.3</b>	<b>24 / 7.0</b>	<b>30 / 8.8</b>	<b>36 / 10.6</b>	<b>48 / 14.1</b>	<b>54 / 15.8</b>
Indoor Model Name	AVNQ18GM1T1	AVNQ24GM1T1	AVNQ30GM1T1	AVNQ36GM2T1	AVNQ48GM2T1	AVNQ54GM2T1
Outdoor Model Name	AVUQ18GM1T1	AVUQ24GM1T1	AVUQ30GM1T1	AVUQ36GM2T1	AVUQ48GM2T1	AVUQ54GM2T1

#### FLOOR STANDING

						
<b>kBtu / kW</b>					<b>48 / 14.1</b>	<b>96 / 28.2</b>
Indoor Model Name					APNQ50LT3E0	APNQ100LFT0
Outdoor Model Name					APUQ50LT3E0	APNQ100LFT0

#### SINGLE PACKAGE

<b>Capacity (RT)</b>				<b>6.5, 7.5 RT</b>	<b>10, 12.5 RT</b>	<b>15, 17.5, 20, 25 RT</b>
Single Package						
Model Name				AK-Q0788C01 AK-Q0908C01	AK-Q1208C01 AK-Q1508C01	AK-Q1808C01 / AK-Q2108C01 AK-Q2408C01 / AK-Q3008C01

# PRODUCT LINE-UP

## STANDARD

### TROPICAL HEAT

#### CEILING CASSETTE

						
<b>kBtu / kW</b>	<b>18 / 5.3</b>	<b>24 / 7.0</b>	<b>30 / 8.8</b>	<b>36 / 10.6</b>	<b>48 / 14.1</b>	<b>54 / 15.8</b>
Indoor Model Name	ATNW18GPLS1	ATNW24GPLS1	ATNW30GPLS1	ATNW36GMLS1	ATNW48GMLS1	ATNW54GMLS1
Outdoor Model Name	ATUW18GPLS1	ATUW24GPLT1	ATUW30GPLS1	ATUW36GMLS1	ATUW48GMLS1	ATUW54GMLS1

#### CEILING CONCEALED DUCT (MIDDLE STATIC)

						
<b>kBtu / kW</b>	<b>18 / 5.3</b>	<b>24 / 7.0</b>	<b>30 / 8.8</b>	<b>36 / 10.6</b>	<b>48 / 14.1</b>	<b>54 / 15.8</b>
Indoor Model Name	ABNW18GM1S1	ABNW24GM1S1	ABNW30GM1S1	ABNW36GM2S1	ABNW48GM3S1	ABNW54GM3S1
Outdoor Model Name	ABUW18GM1S1	ABUW24GM1S1	ABUW30GM1S1	ABUW36GM2S1	ABUW48GM3S1	ABUW54GM3S1

#### FLOOR STANDING

						
<b>kBtu / kW</b>			<b>24</b>	<b>36 / 10.6</b>	<b>48 / 14.1</b>	
Indoor Model Name			APNW24GS1S1	APNW36GT3S1	APNW48GT3S1	
Outdoor Model Name			APUW24GS1S1	APUW36GT3S1	APUW48GT3S1	

### COOL

#### CEILING CASSETTE

					
<b>kBtu / kW</b>	<b>18 / 5.3</b>	<b>24 / 7.0</b>	<b>36 / 10.6</b>	<b>48 / 14.1</b>	<b>54 / 15.8</b>
Indoor Model Name	ATNQ22GPLA4	ATNQ30GPLA4	ATNQ40GNLA4	ATNQ50GMLA4	ATNQ60GMLA4
Outdoor Model Name	ATUQ22GPLA4	ATUQ30GPLA4	AUUQ40GH4	AUUQ50GH4	AUUQ60GH4

#### CEILING CONCEALED DUCT (MIDDLE STATIC)



					
<b>kBtu / kW</b>	<b>18 / 5.3</b>	<b>24 / 7.0</b>	<b>36 / 10.6</b>	<b>48 / 14.1</b>	<b>54 / 15.8</b>
Indoor Model Name	ABNQ22GM1A4	ABNQ30GM1A4	ABNQ40GM3A4	ABNQ50GM3A4	ABNQ60GM3A4
Outdoor Model Name	ABUQ22GM1A4	ABUQ30GM1A4	AUUQ40GH4	AUUQ50GH4	AUUQ60GH4

#### FLOOR STANDING



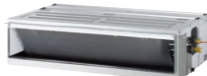

						
<b>kBtu / kW</b>			<b>18</b>	<b>30</b>		
Indoor Model Name			APNQ18GS1K1	APNQ30GS1K1		
Outdoor Model Name			APUQ18GS1K1	APUQ30GS1K1		

### HEAT

#### CEILING CONCEALED DUCT (LOW STATIC)

	
<b>kBtu / kW</b>	<b>12</b>
Indoor Model Name	ABNW12GL5S1
Outdoor Model Name	ABUW12GL5S1

#### CEILING SUSPENDED

			
<b>kBtu / kW</b>	<b>36 / 10.6</b>	<b>48 / 14.1</b>	<b>60</b>
Indoor Model Name	AVNW36GM1S1	AVNW48LM2S1	AVNW60LM2S1
Outdoor Model Name	AUUW36GS1	AUUW48LS1	AUUW54LS1

# ENERGY SAVING

# ENERGY SAVING

SINGLE SPLIT BENEFIT

## COMFORT COOLING WITH HUMIDITY SENSOR

'Comfort Cooling' is a energy saving function that changes evaporation temperature according to temperature & humidity.

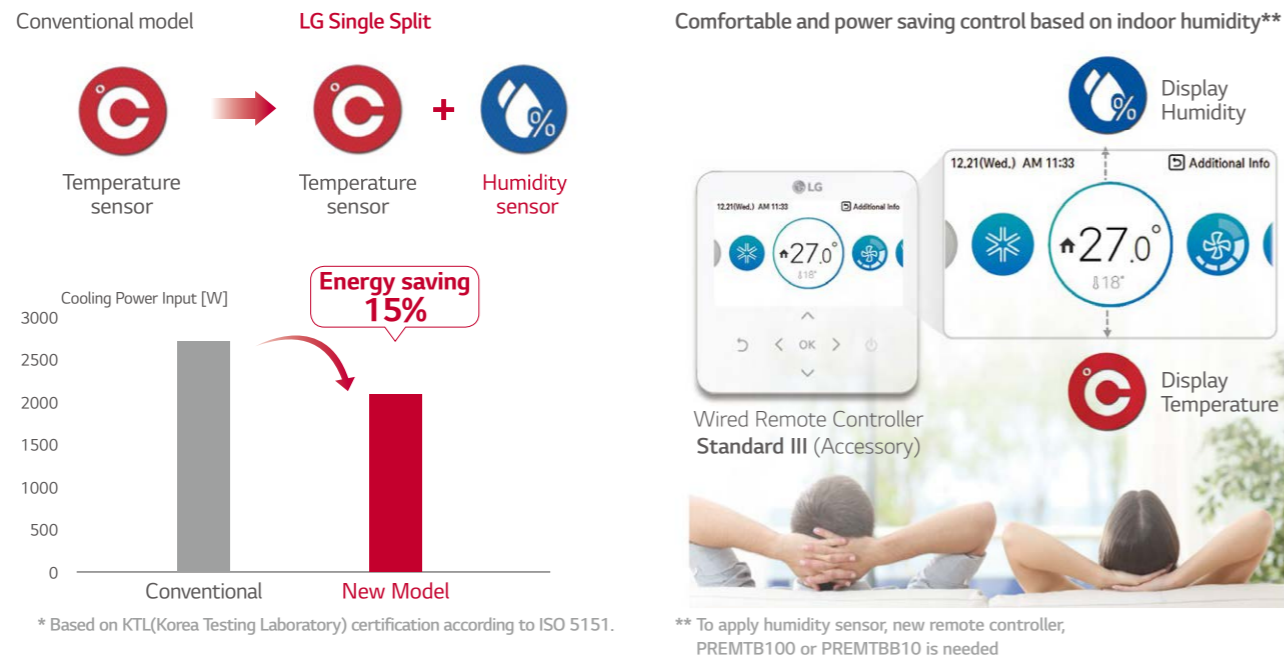

## ENERGY SAVING WITH HUMAN DETECTION SENSOR

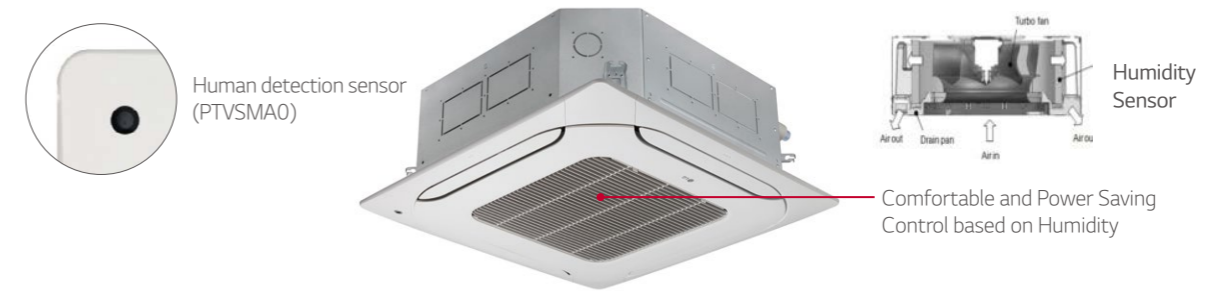

### Direction control based on human motion

Air flow direction is controlled automatically by motion sensor that detects the activity of people every 10seconds.

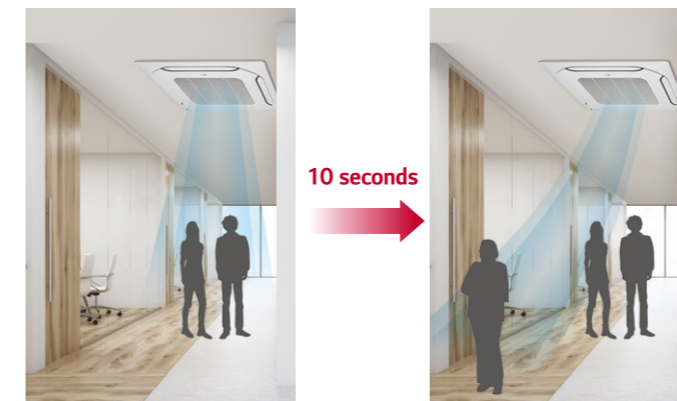

### Compressor control based on real load

Discharge temperature is controlled by the number of occupancy.

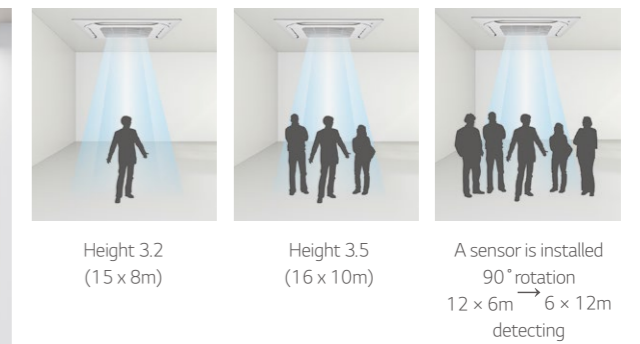

**LG SINGLE SPLIT (Dry Summer)**

Dry Summer 27°C 15%<sup>1)</sup>

Comfort

Low High

Te<sup>2)</sup> + α Refrigerants

**Comfortable Environment**  
By making the room less dry

**Increased Energy Efficiency**  
Provide optimized cooling and save energy considering humidity

**Max.18% Energy Saving\***

**LG SINGLE SPLIT (Wet Summer)**

Wet Summer 27°C 85%<sup>1)</sup>

Comfort

Low High

Te<sup>2)</sup> + α Refrigerants

시험결과서 (Test Report)

\* Room Temperature : 20.5°C  
Humidity : 50 ± 10%  
Applied model : AT\*18GPLT

1) Indoor Condition  
2) Evaporation Temperature

### Auto on/off mode

The indoor unit automatically stops when detecting absence. It runs as the same as previous mode when sensing human body.

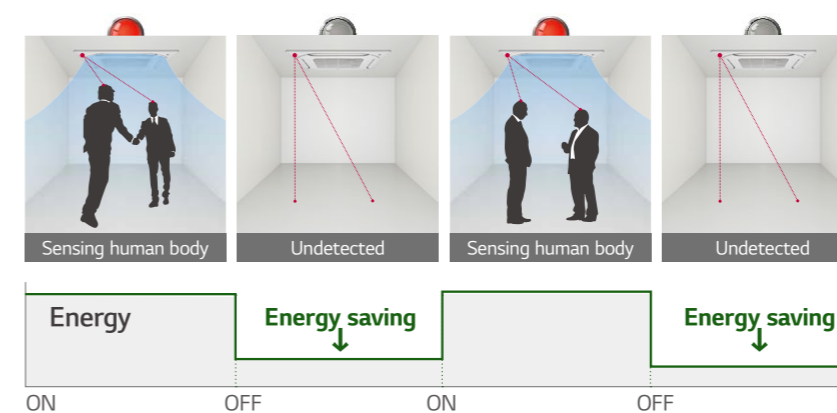

**Max.35% Energy Saving\***

※ Sensor is optional accessory (PTVSMAD) : only can be applied to PT-MCHW0(CST Panel) ※ This mode can be operated when you select "On/Off power saving"  
※ To use this function, new remote controller, PREMTB100 or PREMTBB10 is needed

# ENERGY SAVING

# COMFORT

SINGLE SPLIT BENEFIT

## BENEFIT OF PARTIAL LOAD PERFORMANCE

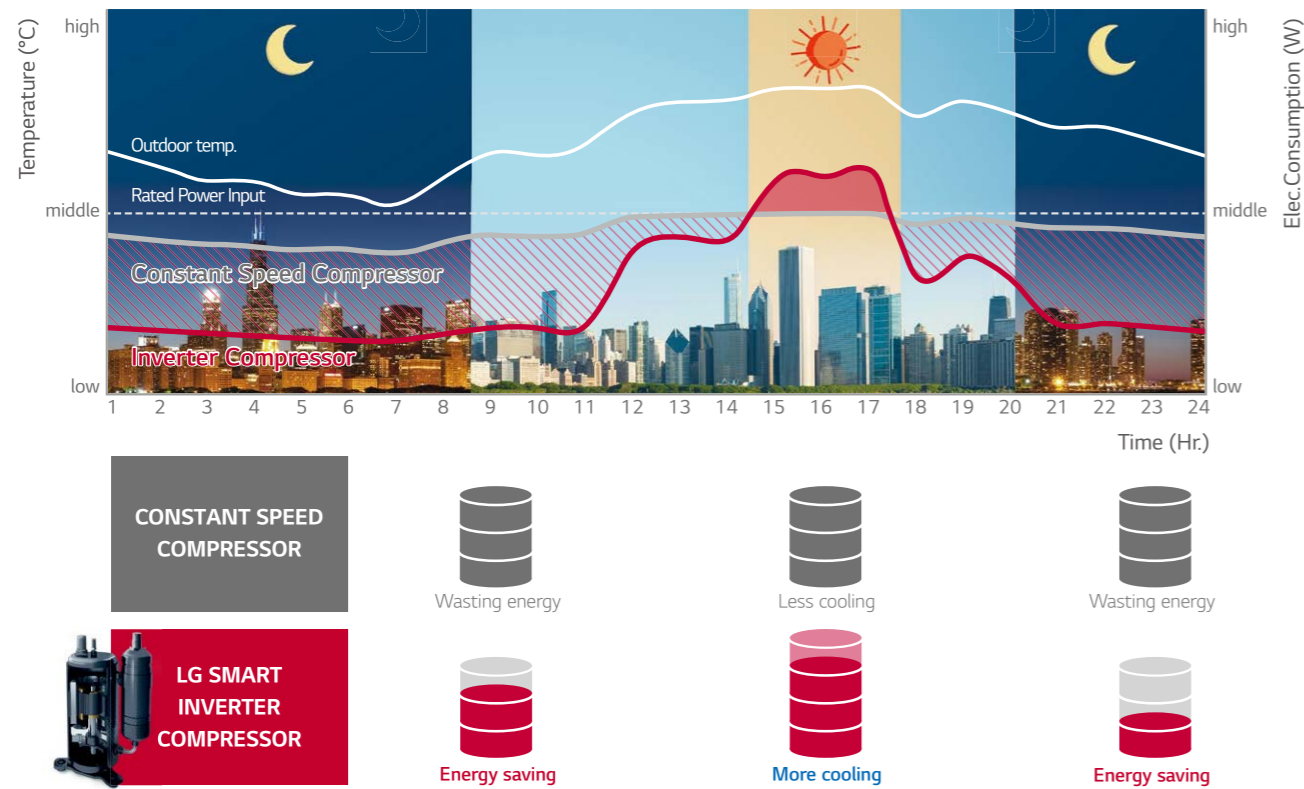

## QUICK COOLING WITH SMART SENSOR

At the same condition, the inverter reaches the set temperature about 30% faster than the constant speed.

SMART SENSORS

Temperature Sensor + Pressure Sensor

Sensing and ready for operation

Quick and reliable operation

# 30%

## QUICK COOLING

\* 30% faster than the constant speed

## EER vs SEER

The difference of EER is very small, but the difference of SEER is much bigger. This means that inverter air conditioner saves annual operation cost a lot more than constant speed air conditioner.

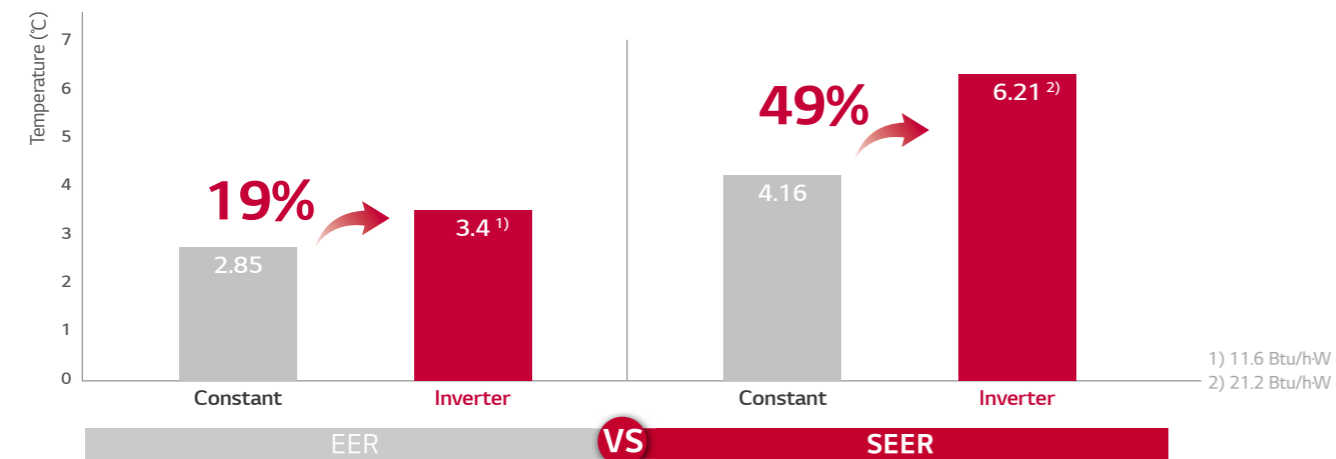

※ EER: Indoor Temp. 27°C (DB) / 19°C (WB), Outdoor Temp. 35°C (DB) / 24°C (WB)  
 ※ SEER (seasonal energy efficiency ratio):  
 - Indoor Temp. 26.7°C (DB) / 19.4°C (WB)  
 - Outdoor Temp. 35°C / 27.8°C / 30.6°C / 27.8°C / 19.4°C (DB)  
 \* LG internal simulated data

※ Model: 4 Way Cassette (48 kBtu/h)  
 ※ This result can be different depending on actual environment.

## Inverter Control

Smart sensors make quick and precise cooling possible. (Same sensor with Multi V)

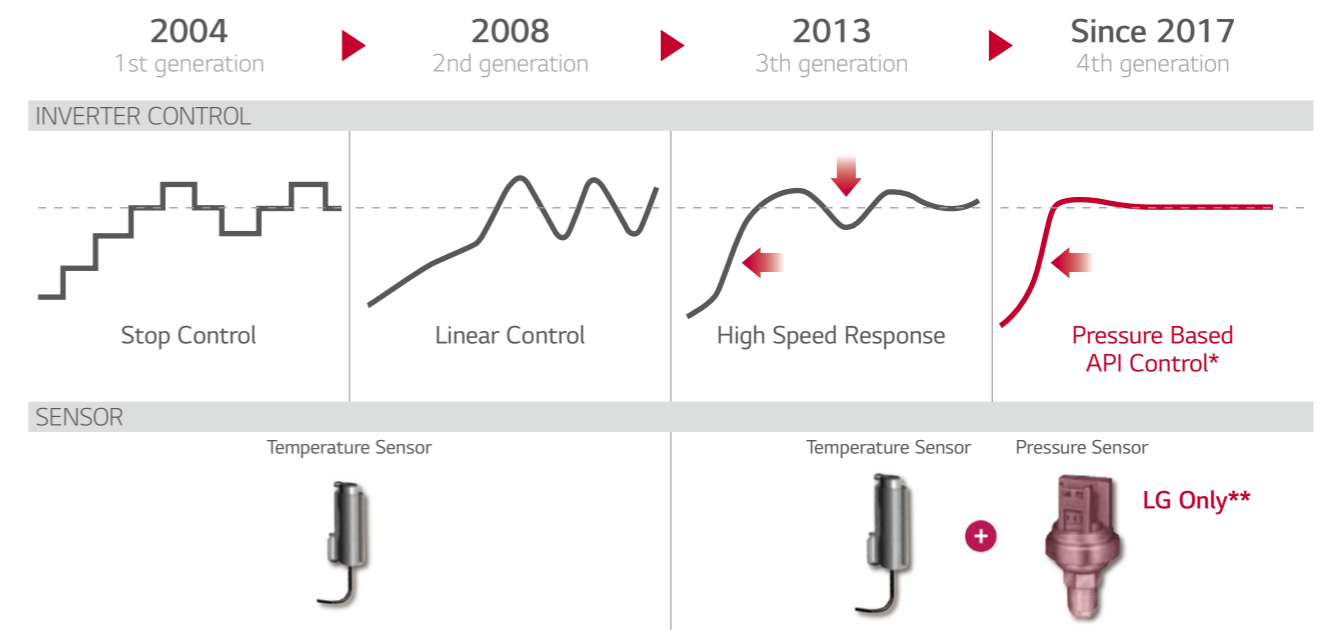

\* API Control: Adaptive Proportional Intergrated control.

# COMFORT

## LOW NOISE

Inverter makes lower noise than constant speed due to adjustable frequency according to the load.

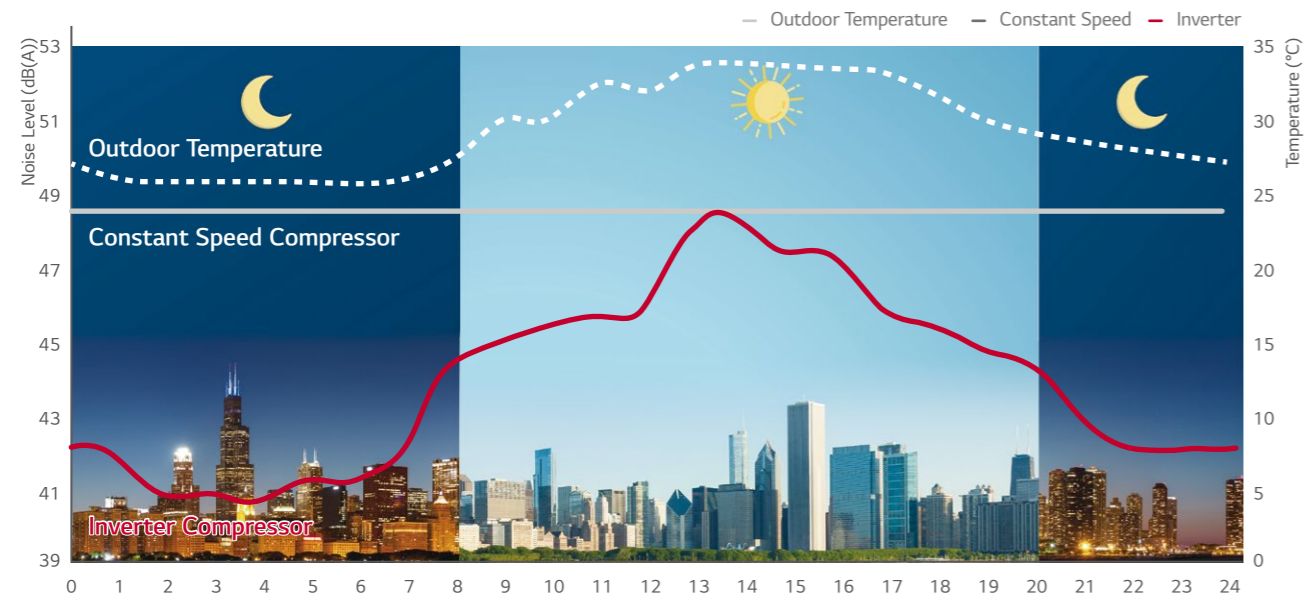

※ Noise level in residential environment : 60dB(A) : Normal conversation, 50dB(A) : office, 40dB(A) : Livingroom  
 ※ This result can be different depending on actual environment.  
 ※ The value of noise level is based on "A\*UW18G\*\*T2"

## OPTIMUM COOLING

When indoor temperature reaches near to the target temperature, LG Smart Inverter adjusts its discharge air temperature to prevent the indoor from being overcooled.



# RELIABILITY



## HIGH AND LOW VOLTAGE PROTECTION

Below low voltage limit, inverter compressor reduces frequency(Hz) and boost DC voltage, over high voltage limit, cuts off the relay to prevent damage of DC capacitor.

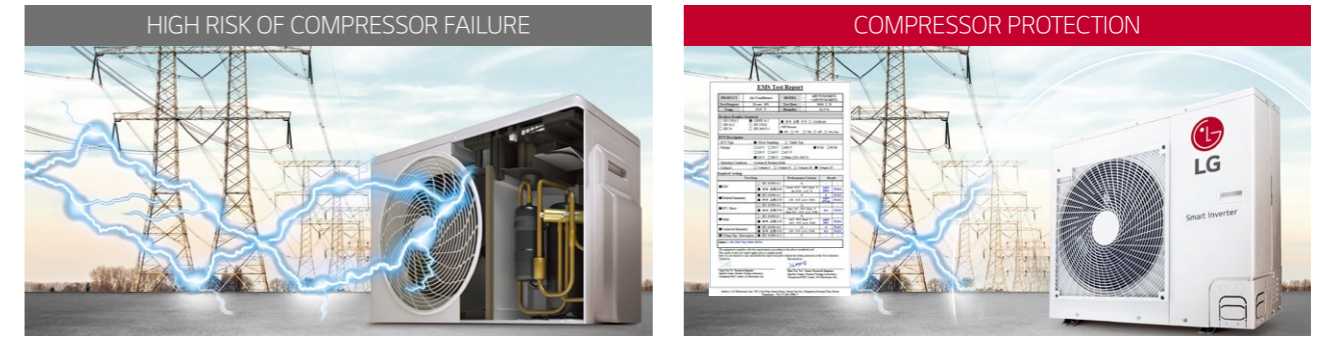

## WIDE OPERATION RANGE

Be able to operate at extreme conditions.



※ Differences of operation range by model type.

## CORROSION RESISTANT HEAT EXCHANGER

The fin of heat exchanger covered with gold-colored special coating prevents corrosion, extending the lifespan of the unit.

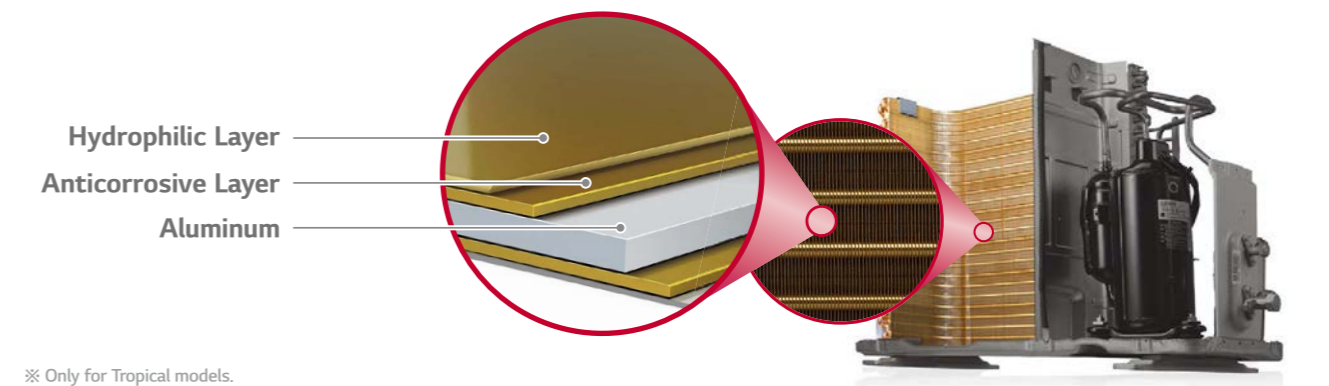

※ Only for Tropical models.

# RELIABILITY

## POWER COOLING AT THE LONG PIPE

It has capacity of 10% higher more than constant model at the 50m pipe length.

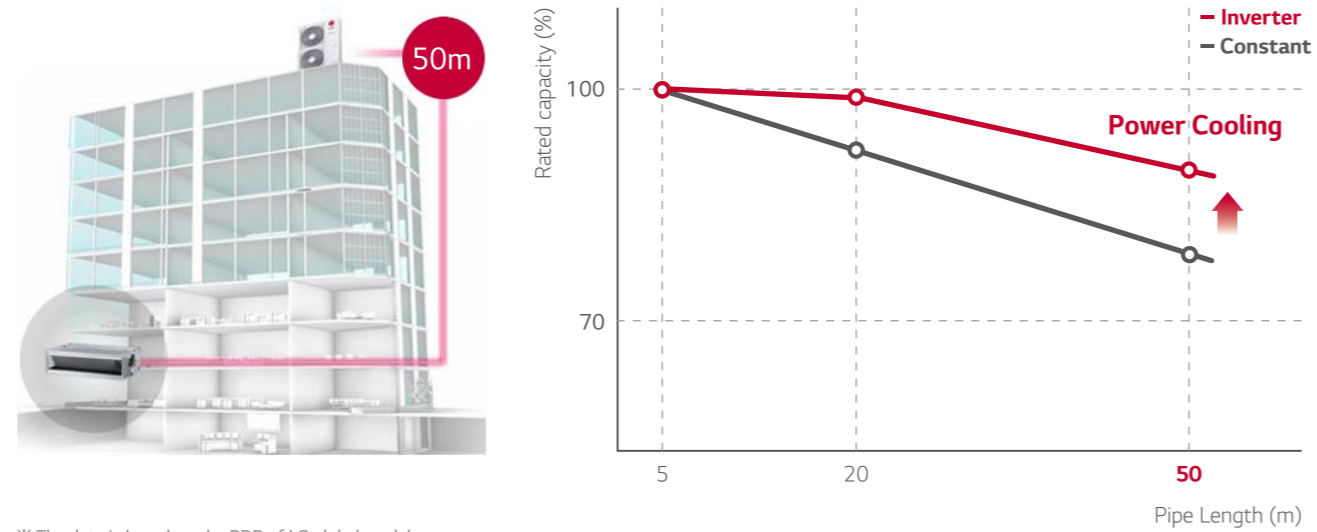

※ The data is based on the PDB of LG global model.  
 ※ Test condition (Temperature) : 27 / 35 °C (Indoor / Outdoor)

## DETECTION OF REFRIGERANT SHORTAGE

Detect the refrigerant level continuously and judge if the refrigerant insufficient. If the amount of refrigerant is under 60% in the system, it can check the error display of remote controller and running will be stopped.



# RELIABILITY

## BLACK BOX FOR EMERGENCY

Quick Service can be done because operation data is saved before system failure.

WITHOUT BLACK BOX FUNCTION	WITH BLACK BOX FUNCTION
<p>Check many reasons of failure and error codes in person</p> <p>Take much service time and undergo trial and error</p>	<p>Record operation data for Autosave function before system failure!</p> <p>Search for a reason of failure easily by using recorded data</p> <p>Save service time and diagnose product more accurately</p>

※ It can be checked by using SIMs or LG MV

# CONVENIENCE

# CONVENIENCE

SINGLE SPLIT BENEFIT

## LG ThinQ

Control your air conditioners via using the smart internet devices such as Android or iOS based smart phones. This advanced technology provides you the best convenience.



### Simple operation for various functions



- On / Off
- Mode Selection
- Current temperature
- Set temperature
- Vane Control
- Reservation
- Energy Monitoring
- Filter Management

※ Search "LG Smart ThinQ" on Google market or Appstore then download the app.  
 ※ Wi-Fi modem (PWFMD200) is required by option.

### Access your air conditioner anytime and from anywhere



## SIMPLE TEST RUN VIA LGMV (MONITORING VIEWER)

Fast and accurate auto test run can be executed and the professional installer running the test can receive test results via email, which shortens installation hours and increases overall efficiency in installation processes.

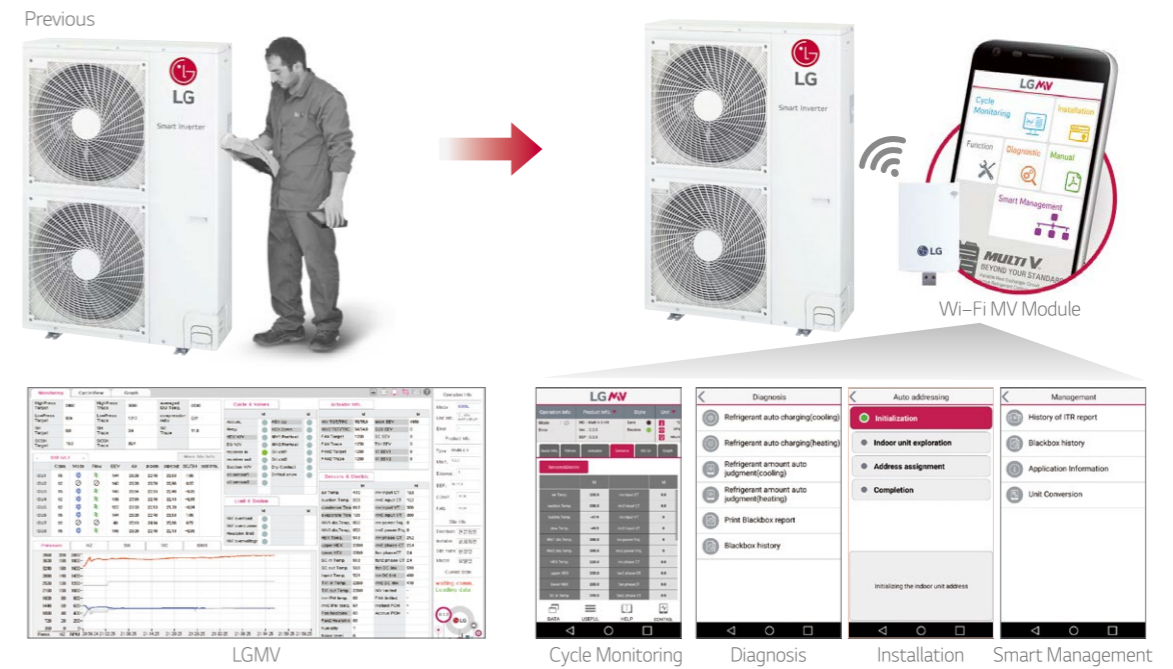

## Easy Registration and Log-in

Follow the easy set-up steps. It will show LG ThinQ's impressive features.

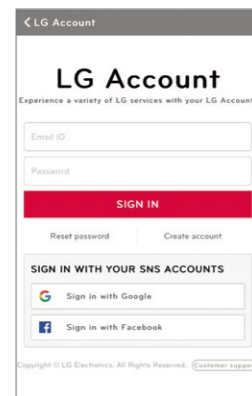

## Wi-Fi Connectivity



※ Can be controlled by multiple users, but not simultaneously.

### Simple operation for various functions

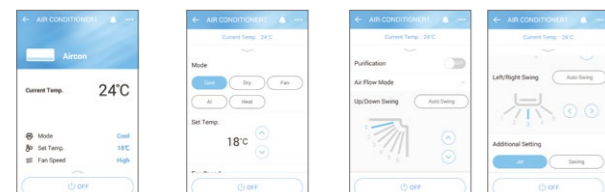

On / Off, Current Temp. Mode, Set Temp. Vane Control

### Straight forward Management

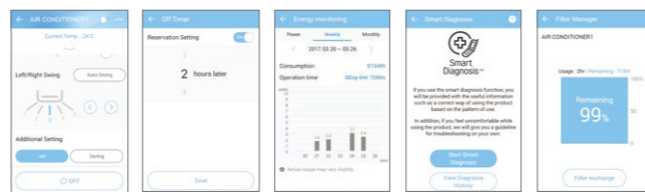

Reservation Energy Monitoring Smart Diagnosis Filter Management

## WEEKLY PROGRAM

You can set the daily temperature and automatic on/off time for one week. It will keep running depending on that time before the user changes or cancels it.

Week Schedule

	A	B	C	D	E
Monday	✓				
Tuesday	✓	✓		✓	
Wednesday		✓		✓	✓
Thursday		✓	✓		✓
Friday	✓		✓		
Saturday		✓		✓	✓
Sunday				✓	✓

※ Two weekly reservation Max. 14 schedule for a week.





# HIGH EFFICIENCY STANDARD EFFICIENCY SINGLE SPLIT

- Ceiling Mounted Cassette
- Ceiling Concealed Duct
- Ceiling Suspended Unit
- Floor Standing Unit
- Single Package



# CEILING MOUNTED CASSETTE



## STYLISH DESIGN PANEL

New 4 way cassette panel adapted a unibody shape that matches with the ceiling.

### Interior fit



### Lineless surface

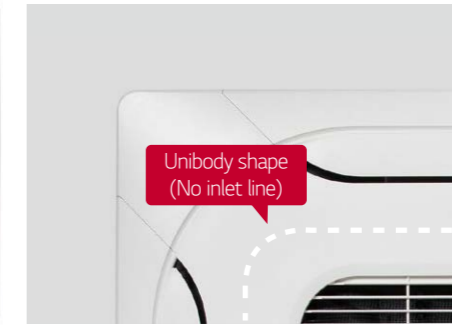

### Detachable corner

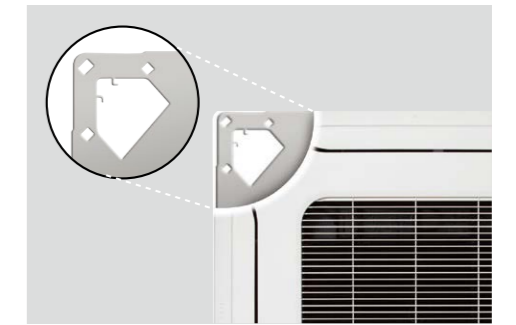

※ New Panel : PT-MCHW0

CASSETTE

## COMPACT SIZE

Slim & compact design not only saves space but also reduces installation costs. It's designed to be suitable for most of building designs and fits into various spaces.

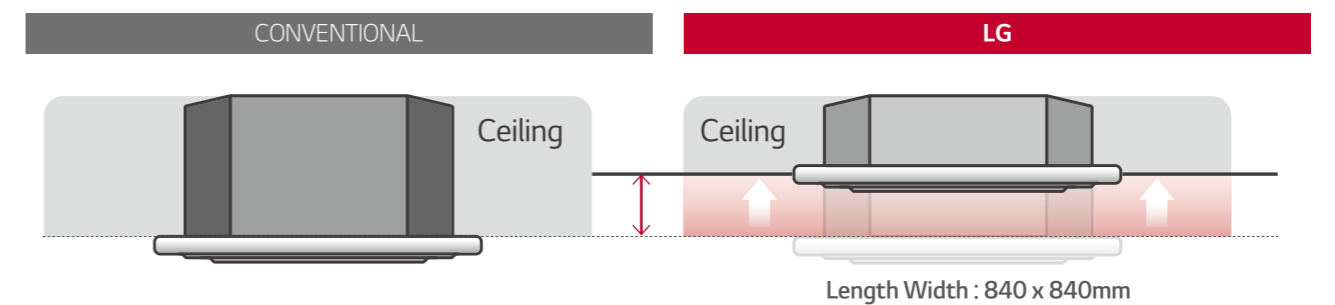

Height	Size
ATN*18/24/30GPLT1(S1)	204mm
ATN*36GNLT1(S1)	246mm
ATN*48/54GMLT1(S1)	288mm

## INDEPENDENT VANE OPERATION

The independent vane operation feature uses separate motors, making it possible to control all four vanes independently.

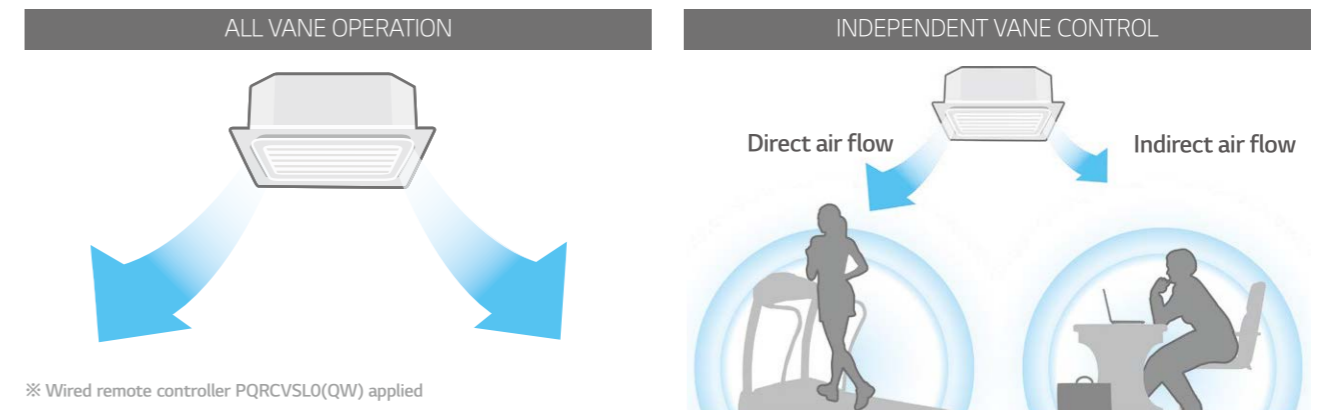

※ Wired remote controller PQRCVSL0(QW) applied

# CEILING MOUNTED CASSETTE

## HIGH CEILING MODE

Airflow in a space with a 4.2m ceiling height is available with this indoor unit. Further, air flow can be strengthened by adjusting the fan speed.

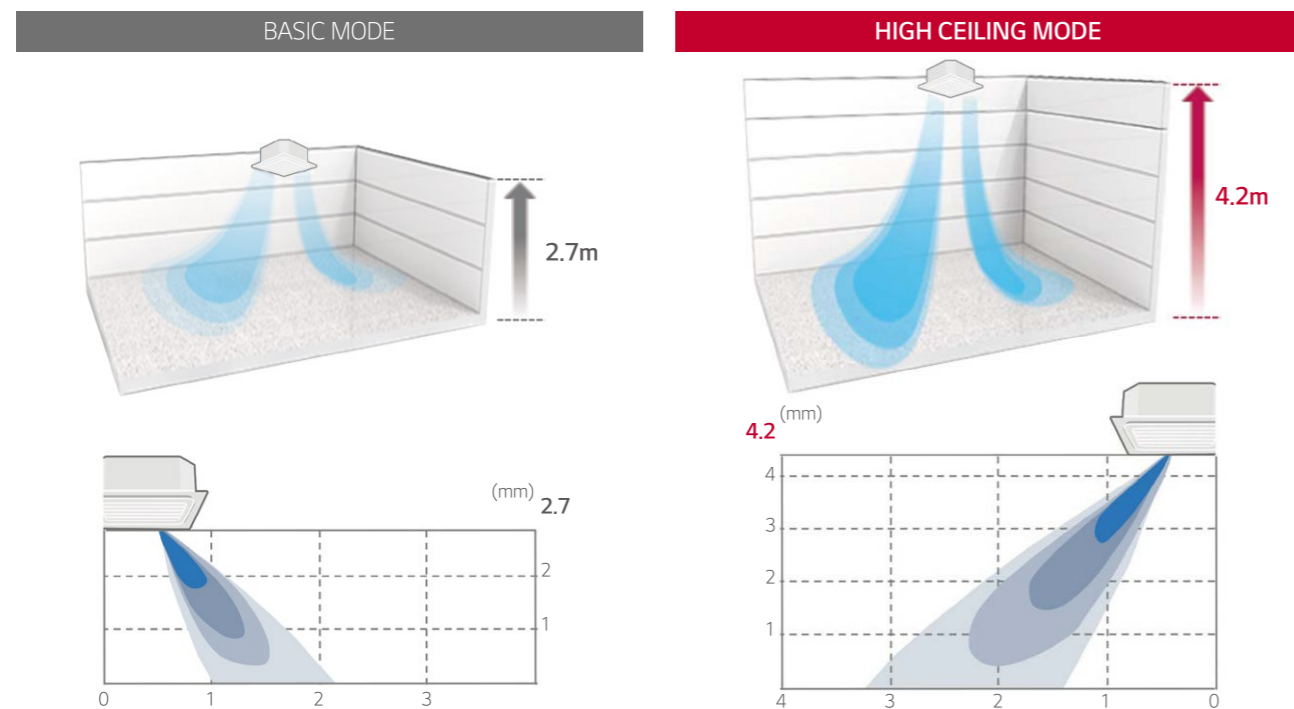

## CONVENIENT PANEL INSTALLATION

The detachable corner design makes it easy to adjust the hanger during installation and to check leakages in the drain connection pipe. It is easy to install the panel to the body, using the button type panel design.

### Detachable Corner Design

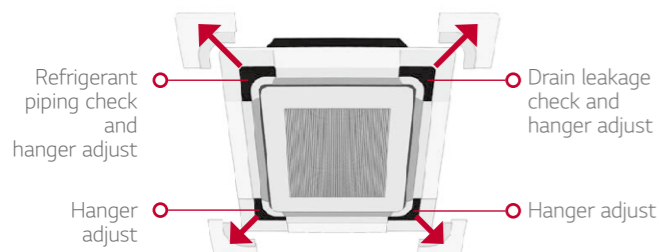

### Drain Leakage Check

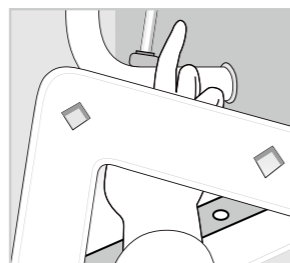

### Hanger Adjust

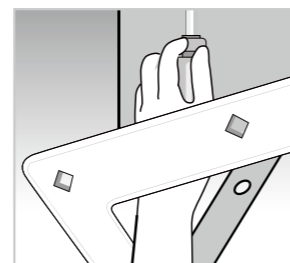

It is easy to install the panel to the body, using the button type panel design.

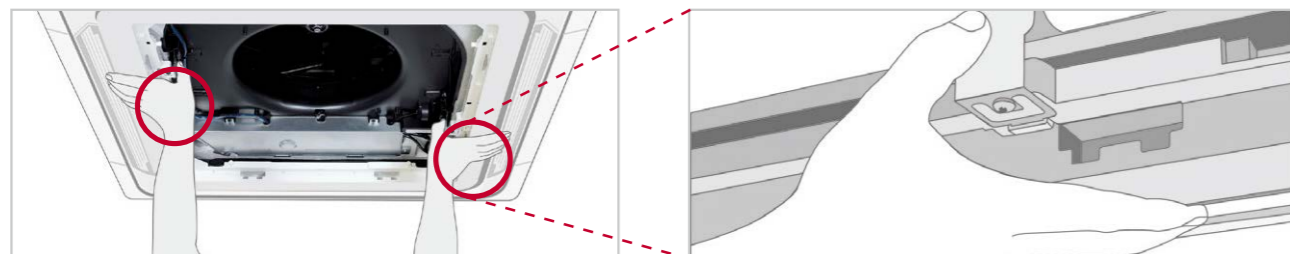

## PREVENT CEILING POLLUTION

Coanda design of air outlet can prevent contamination of ceiling.

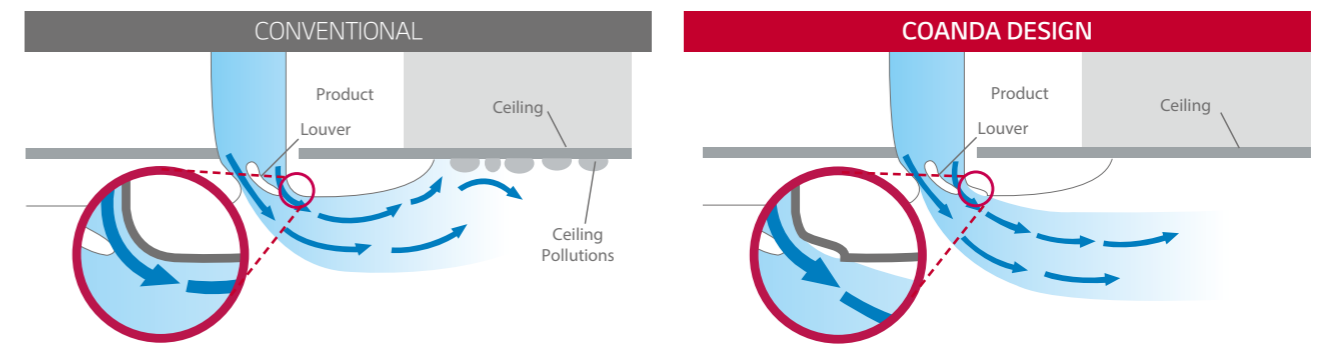

## CASSETTE PANEL

### Key Features

Stylish designed panels make more unique space by various applications.

### 4 Way Cassette Panel



PT-QCHW0, PT-MCHW0

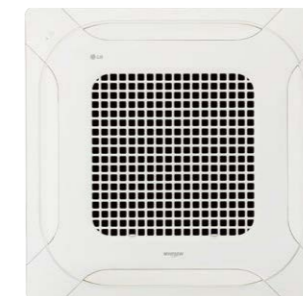

PT-MCGW0, PT-MPGW0 (Air Purification)

## Specification

Model	Suction Type	Color (RAL)	Gloss	Weight (kg)	Dimension (mm)			Applied model capacity (kW)*					
					W	H	D	MULTI V		Single Split		Multi Split	
								R410A	R32	R410A	R32	R410A	
4 Way	PT-QCHW0	Grill	Morning Fog (RAL 9001)	-	3.0	620	35	620	1.6 - 6.2	2.5 - 5.0	2.5 - 5.0	1.5 - 5.3	1.5 - 5.3
	PT-MCHW0	Grill	Morning Fog (RAL 9001)	-	6.3	950	35	950	7.1 - 15.8	6.8 - 14.6	6.8 - 14.6	6.7	-
	PT-MCGW0	Grill	Morning Fog (RAL 9001)	-	5.0	950	35	950	7.1 - 15.8	6.8 - 14.6	6.8 - 14.6	6.7	6.7
	PT-MPGW0 (Air Purify)	Grill	Morning Fog (RAL 9001)	-	6.6	950	35	950	7.1 - 15.8	6.8 - 14.6	6.8 - 14.6	6.7	6.7

# SPECIFICATIONS

## CEILING MOUNTED CASSETTE - HIGH EFFICIENCY



CASSETTE

### TROPICAL HEAT

Combination	Outdoor unit		Unit	ATUW18GPLT1	ATUW24GPLT1
	Indoor unit			ATNW18GPLT1	ATNW24GPLT1
Cooling Capacity <sup>1</sup>	Min. - Rated - Max.		kW	2.1-5.27-5.86	2.81-7.03-8.2
			Btu/h	7,200-18,000-20,000	9,600-24,000-28,000
Cooling Capacity <sup>2</sup>	Min. - Rated - Max.		kW	4.53	5.86
			Btu/h	15,450	20,000
Heating Capacity <sup>1</sup>	Min. - Rated - Max.		kW	2.1-5.27-6.1	2.8-7.03-8.2
			Btu/h	7,200-18,000-21,000	9,600-24,000-28,000
Power Input	Cooling <sup>1</sup>	Rated	kW	1.55	2.06
	Cooling <sup>2</sup>	Rated	kW	1.71	2.25
	Heating <sup>1</sup>	Rated	kW	1.50	2.05
EER / COP			W/W	3.4/3.51	3.41/3.43
<b>Outdoor</b>			<b>Unit</b>	<b>ATUW18GPLT1</b>	<b>ATUW24GPLT1</b>
Power Supply			V, Ø, Hz	220 - 240, 1, 50	220 - 240, 1, 50
Power Supply Cable (included Earth)			No. x mm <sup>2</sup>	3C x 2.5	3C x 2.5
Casing Color			-	Warm Gray	Warm Gray
Dimensions	Net	W x H x D	mm	770 x 545 x 288	870 x 650 x 330
Weight	Net		kg	35.2	45.5
Compressor	Type		-	Twin Rotary	Twin Rotary
Fan Motor	Type			BLDC	BLDC
Sound Pressure Level	Cooling	Rated	dB(A)	49	50
	Heating	Rated	dB(A)	52	52
Piping Connections	Liquid	Outer Dia.	mm (inch)	Ø 6.35 (1/4)	Ø 9.52 (3/8)
	Gas	Outer Dia.	mm (inch)	Ø 12.7 (1/2)	Ø 15.88 (5/8)
Piping Length		Rated	m	5	5
		Max.	m	30	50
Maximum Height Difference (ODU - IDU)		Max.	m	15	30
<b>Indoor</b>			<b>Unit</b>	<b>ATNW18GPLT1</b>	<b>ATNW24GPLT1</b>
Power Supply			V, Ø, Hz	220-240, 1, 50	220-240, 1, 50
Dimensions	Net	W x H x D	mm	840 x 204 x 840	840 x 204 x 840
	Shipping	W x H x D	mm	922 x 276 x 917	922 x 276 x 917
Weight	Net		kg	19.6	20.5
Air Flow Rate		H / M / L	m <sup>3</sup> /min	17.0 / 15.0 / 13.0	17.0 / 15.0 / 13.0
Fan Motor	Type			BLDC	BLDC
Safety Device				Fuse	Fuse
Sound Pressure Level		H / M / L	dB(A)	36 / 34 / 32	38 / 36 / 34

### TROPICAL HEAT

ATUW30GPLT1	ATUW36GNLT1	ATUW48GMLT1	ATUW54GMLT1
ATNW30GPLT1	ATNW36GNLT1	ATNW48GMLT1	ATNW54GMLT1
3.44-8.2-9.38	4.7-9.99-11.13	5.39-13.48-15.53	6.33-15.82-16.70
11,760-28,000-32,000	16,030-34,100-38,000	18,400-46,000-53,000	21,600-54,000-57,000
7.38	8.49	11.45	12.34
25,200	28,980	39,100	42,120
3.28-8.2-9.09	4.0-9.99-10.84	5.62-14.06-15.8	6.56-16.41-17.6
11,200-28,000-31,000	13,640-34,100-37,000	19,200-48,000-54,000	22,400-56,000-60,000
2.41	2.93	3.96	5.39
3.02	3.44	4.66	5.40
2.33	2.84	4.00	5.09
3.4/3.52	3.41/3.52	3.4/3.52	2.94/3.22
<b>ATUW30GPLT1</b>	<b>ATUW36GNLT1</b>	<b>ATUW48GMLT1</b>	<b>ATUW54GMLT1</b>
220-240, 1, 50	220-240, 1, 50	220-240, 1, 50	220-240, 1, 50
3C x 2.5	3C x 2.5	3C x 6.0	3C x 6.0
Warm Gray	Warm Gray	Warm Gray	Warm Gray
950 x 834 x 330	950 x 834 x 330	950 x 1,380 x 330	950 x 1,380 x 330
60.8	60.8	90.2	90.2
Twin Rotary	Twin Rotary	LG Inverter Scroll	LG Inverter Scroll
BLDC	BLDC	BLDC	BLDC
51	51	55	55
53	53	57	57
Ø 9.52 (3/8)	Ø 9.52 (3/8)	Ø 9.52 (3/8)	Ø 9.52 (3/8)
Ø 15.88 (5/8)	Ø 15.88 (5/8)	Ø 19.05 (3/4)	Ø 19.05 (3/4)
5	5	5	5
50	50	75	75
30	30	30	30
<b>ATNW30GPLT1</b>	<b>ATNW36GNLT1</b>	<b>ATNW48GMLT1</b>	<b>ATNW54GMLT1</b>
220-240, 1, 50	220-240, 1, 50	220-240, 1, 50	220-240, 1, 50
840 x 204 x 840	840 x 246 x 840	840 x 288 x 840	840 x 288 x 840
922 x 276 x 917	922 x 318 x 917	922 x 360 x 917	922 x 360 x 917
20.5	23.3	25.5	25.5
19.0 / 17.0 / 15.0	23.0 / 21.0 / 19.0	32.0 / 30.0 / 28.0	32.0 / 30.0 / 28.0
BLDC	BLDC	BLDC	BLDC
Fuse	Fuse	Fuse	Fuse
41 / 38 / 36	42 / 40 / 38	44 / 42 / 40	44 / 42 / 40

Notes

- Cooling<sup>1</sup> : Indoor Temperature 27°C (80.6°F) DB / 19°C (66.2°F) WB, Outdoor Temperature 35°C (95°F) DB / 24°C (75.2°F) WB
- Cooling<sup>2</sup> : Indoor Temperature 29°C (84.2°F) DB / 19°C (66.2°F) WB, Outdoor Temperature 46°C (114.8°F) DB / 24°C (75.2°F) WB
- Heating Temperature : Indoor 20°C (68°F) DB / 15°C (59°F) WB, Outdoor 7°C (44.6°F) DB / 6°C (42.8°F) WB

# SPECIFICATIONS

## CEILING MOUNTED CASSETTE - HIGH EFFICIENCY



CASSETTE

**TROPICAL COOL**

Combination	Outdoor unit		Unit	ATUQ18GPLT1	ATUQ24GPLT1
	Indoor unit			ATNQ18GPLT1	ATNQ24GPLT1
Cooling Capacity <sup>1</sup>	Min. - Rated - Max.		kW	2.1-5.27-5.86	2.81-7.03-8.2
			Btu/h	7,200-18,000-20,000	9,600-24,000-28,000
Cooling Capacity <sup>2</sup>	Min. - Rated - Max.		kW	4.53	5.86
			Btu/h	15,450	20,000
Power Input	Cooling <sup>1</sup>	Rated	kW	1.55	2.06
	Cooling <sup>2</sup>	Rated	kW	1.71	2.25
EER / COP			W/W	3.4	3.41
<b>Outdoor</b>			<b>Unit</b>	<b>ATUQ18GPLT1</b>	<b>ATUQ24GPLT1</b>
Power Supply			V, ∅, Hz	220-240, 1, 50	220-240, 1, 50
Power Supply Cable (included Earth)			No. × mm <sup>2</sup>	3C × 2.5	3C × 2.5
Casing Color			-	Warm Gray	Warm Gray
Dimensions	Net	W × H × D	mm	770 × 545 × 288	870 × 650 × 330
Weight	Net		kg	34.3	43.3
Compressor	Type		-	Twin Rotary	Twin Rotary
Refrigerant	Type		-	R410A	R410A
Fan Motor	Type			BLDC	BLDC
Sound Pressure Level	Cooling	Rated	dB(A)	49	50
Piping Connections	Liquid	Outer Dia.	mm (inch)	∅ 6.35 (1/4)	∅ 9.52 (3/8)
	Gas	Outer Dia.	mm (inch)	∅ 12.7 (1/2)	∅ 15.88 (5/8)
Piping Length		Rated	m	5	5
		Max.	m	30	50
Maximum Height Difference (ODU - IDU)	Max.		m	15	30
<b>Indoor</b>			<b>Unit</b>	<b>ATNQ18GPLT1</b>	<b>ATNQ24GPLT1</b>
Power Supply			V, ∅, Hz	220-240, 1, 50	220-240, 1, 50
Dimensions	Net	W × H × D	mm	840 × 204 × 840	840 × 204 × 840
	Shipping	W × H × D	mm	922 × 276 × 917	922 × 276 × 917
Weight	Net		kg	19.6	20.5
Air Flow Rate		H / M / L	m <sup>3</sup> /min	17.0 / 15.0 / 13.0	17.0 / 15.0 / 13.0
Fan Motor	Type			BLDC	BLDC
Safety Device				Fuse	Fuse
Sound Pressure Level		H / M / L	dB(A)	36 / 34 / 32	38 / 36 / 34

Notes

- Cooling<sup>1</sup>: Indoor Temperature 27°C (80.6°F) DB / 19°C (66.2°F) WB, Outdoor Temperature 35°C (95°F) DB / 24°C (75.2°F) WB  
 - Cooling<sup>2</sup>: Indoor Temperature 29°C (84.2°F) DB / 19°C (66.2°F) WB, Outdoor Temperature 46°C (114.8°F) DB / 24°C (75.2°F) WB

**TROPICAL COOL**

ATUQ30GPLT1	ATUQ36GNLT1	ATUQ48GMLT1	ATUQ54GMLT1
ATNQ30GPLT1	ATNQ36GNLT1	ATNQ48GMLT1	ATNQ54GMLT1
3.44-8.2-9.38	4.7-9.99-11.13	5.39 - 13.48 - 15.53	6.33 - 15.82 - 16.70
11,760-28,000-32,000	16,030-34,100-38,000	18,400-46,000-53,000	21,600-54,000-57,000
7.38	8.49	11.45	12.34
25,200	28,980	39,100	42,120
2.41	2.93	3.96	5.39
3.02	3.44	4.66	5.40
3.4	3.41	3.4	2.94
<b>ATUQ30GPLT1</b>	<b>ATUQ36GNLT1</b>	<b>ATUQ48GMLT1</b>	<b>ATUQ54GMLT1</b>
220-240, 1, 50	220-240, 1, 50	220-240, 1, 50	220-240, 1, 50
3C × 2.5	3C × 2.5	3C × 6.0	3C × 6.0
Warm Gray	Warm Gray	Warm Gray	Warm Gray
950 × 834 × 330	950 × 834 × 330	950 × 1,380 × 330	950 × 1,380 × 330
59.1	59.1	89.5	89.5
Twin Rotary	Twin Rotary	LG Inverter Scroll	LG Inverter Scroll
R410A	R410A	R410A	R410A
BLDC	BLDC	BLDC	BLDC
51	51	55	55
∅ 9.52 (3/8)	∅ 9.52 (3/8)	∅ 9.52 (3/8)	∅ 9.52 (3/8)
∅ 15.88 (5/8)	∅ 15.88 (5/8)	∅ 19.05 (3/4)	∅ 19.05 (3/4)
5	5	5	5
50	50	75	75
30	30	30	30
<b>ATNQ30GPLT1</b>	<b>ATNQ36GNLT1</b>	<b>ATNQ48GMLT1</b>	<b>ATNQ54GMLT1</b>
220-240, 1, 50	220-240, 1, 50	220-240, 1, 50	220-240, 1, 50
840 × 204 × 840	840 × 246 × 840	840 × 288 × 840	840 × 288 × 840
922 × 276 × 917	922 × 318 × 917	922 × 360 × 917	922 × 360 × 917
20.5	23.3	25.5	25.5
19.0 / 17.0 / 15.0	23.0 / 21.0 / 19.0	32.0 / 30.0 / 28.0	32.0 / 30.0 / 28.0
BLDC	BLDC	BLDC	BLDC
Fuse	Fuse	Fuse	Fuse
41 / 38 / 36	42 / 40 / 38	44 / 42 / 40	44 / 42 / 40

# SPECIFICATIONS

## CEILING MOUNTED CASSETTE - STANDARD



### TROPICAL HEAT

Combination	Outdoor unit		Unit	ATUW18GPLS1	ATUW24GPLS1
	Indoor unit			ATNW18GPLS1	ATNW24GPLS1
Capacity	Cooling <sup>1</sup>	Min. - Rated - Max.	kW	1.8 - 5.2 - 5.5	2.8 - 7.0 - 8.1
		Min. - Rated - Max.	Btu/h	6,100 - 17,700 - 18,800	9,600 - 23,900 - 27,600
	Cooling <sup>2</sup>	Rated	kW	4.20	5.75
		Rated	Btu/h	14,300	19,600
	Heating	Min. - Rated - Max.	kW	1.9 - 5.3 - 5.8	3.0 - 7.6 - 8.6
		Min. - Rated - Max.	Btu/h	6,500 - 18,100 - 19,800	10,200 - 25,900 - 29,300
Power Input	Cooling <sup>1</sup>	Rated	kW	1,620.00	2,325.00
	Cooling <sup>2</sup>	Rated	kW	1,750.00	2,600.00
	Heating	Rated	kW	1,560.00	2,235.00
EER / COP	Cooling <sup>1</sup> / Heating		W / W	3.21 / 3.41	3.01 / 3.40
<b>Outdoor Unit</b>				<b>ATUW18GPLS1</b>	<b>ATUW24GPLS1</b>
Power Supply			V, Ø, Hz	220-240, 1, 50	220-240, 1, 50
Power Supply Cable (included Earth)			No. x mm <sup>2</sup> (AWG)	3C x 2.5 (12)	3C x 2.5 (12)
Casing Color			-	Warm Gray	Warm Gray
Dimensions		W x H x D	mm	770 x 545 x 288	870 x 650 x 330
Net Weight		Body	kg (lbs)	35.5 (78.3)	44.8 (98.8)
Compressor	Type		-	Twin Rotary	Twin Rotary
Refrigerant	Type		-	R410A	R410A
Fan Motor	Type		-	BLDC	BLDC
Sound Pressure Level	Cooling	Rated	dB(A)	53	55
	Heating	Rated	dB(A)	54	56
Piping Connections	Liquid	Outer Dia.	mm (inch)	Ø 6.35 (1/4)	Ø 9.52 (3/8)
	Gas	Outer Dia.	mm (inch)	Ø 12.7 (1/2)	Ø 15.88 (5/8)
Piping Length		Max.	m (ft)	25 (82.0)	30 (98.4)
Maximum Height Difference		Outdoor Unit - Indoor Unit	Max.	m (ft)	15 (49.2)
<b>Indoor</b>				<b>ATNW18GPLS1</b>	<b>ATNW24GPLS1</b>
Power Supply			V, Ø, Hz	220-240, 1, 50	220-240, 1, 50
Dimensions		Body	W x H x D	mm	840 x 204 x 840
Net Weight			kg (lbs)	21 (46.3)	21 (46.3)
Air Flow Rate		H / M / L	m <sup>3</sup> /min	16.5 / 14.5 / 13.0	17.0 / 15.0 / 13.0
Fan Motor	Type		-	BLDC	BLDC
Sound Pressure Level	Cooling	H / M / L	dB(A)	38 / 36 / 34	40 / 38 / 36
	Heating	H / M / L	dB(A)	38 / 36 / 34	40 / 38 / 36
Safety Devices			-	Fuse	Fuse

### TROPICAL HEAT

ATUW30GPLS1	ATUW36GMLS1	ATUW48GMLS1	ATUW54GMLS1
ATNW30GPLS1	ATNW36GMLS1	ATNW48GMLS1	ATNW54GMLS1
3.0 - 7.8 - 8.4	4.0 - 10.5 - 11.0	5.6 - 14.0 - 15.0	6.0 - 15.0 - 16.0
10,200 - 26,600 - 28,700	13,600 - 35,800 - 37,500	19,100 - 47,800 - 51,200	20,500 - 51,200 - 54,600
6.40	8.70	12.10	12.40
21,800	29,700	41,300	42,300
3.2 - 8.4 - 8.8	4.3 - 11.2 - 11.7	6.1 - 15.3 - 16.5	6.8 - 16.9 - 18.2
10,900 - 28,700 - 30,000	14,700 - 38,200 - 39,900	20,800 - 52,200 - 56,300	23,200 - 57,700 - 62,100
2,590.00	3,490.00	4,380.00	4,950.00
3,150.00	3,500.00	5,140.00	5,250.00
2,770.00	3,190.00	4,490.00	5,450.00
3.01 / 3.01	3.00 / 3.51	3.20 / 3.41	3.03 / 3.10
<b>ATUW30GPLS1</b>	<b>ATUW36GMLS1</b>	<b>ATUW48GMLS1</b>	<b>ATUW54GMLS1</b>
220-240, 1, 50	220-240, 1, 50	220-240, 1, 50	220-240, 1, 50
3C x 2.5 (12)	3C x 2.5 (12)	3C x 6.0 (10)	3C x 6.0 (10)
Warm Gray	Warm Gray	Warm Gray	Warm Gray
870 x 650 x 330	950 x 834 x 330	950 x 1,380 x 330	950 x 1,380 x 330
44.8 (98.8)	58.0 (127.9)	90.0 (198.4)	90.0 (198.4)
Twin Rotary	Twin Rotary	Twin Rotary	Twin Rotary
R410A	R410A	R410A	R410A
BLDC	BLDC	BLDC	BLDC
55	56	55	55
56	58	57	57
Ø 9.52 (3/8)	Ø 9.52 (3/8)	Ø 9.52 (3/8)	Ø 9.52 (3/8)
Ø 15.88 (5/8)	Ø 15.88 (5/8)	Ø 19.05 (3/4)	Ø 19.05 (3/4)
30 (98.4)	40 (131.2)	50 (164.0)	50 (164.0)
30 (98.4)	30 (98.4)	30 (98.4)	30 (98.4)
<b>ATNW30GPLS1</b>	<b>ATNW36GMLS1</b>	<b>ATNW48GMLS1</b>	<b>ATNW54GMLS1</b>
220-240, 1, 50	220-240, 1, 50	220-240, 1, 50	220-240, 1, 50
840 x 204 x 840	840 x 288 x 840	840 x 288 x 840	840 x 288 x 840
21 (46.3)	28 (61.7)	28 (61.7)	28 (61.7)
19.0 / 17.0 / 15.0	28.5 / 24.5 / 21.0	32.0 / 30.0 / 27.5	32.0 / 30.0 / 27.5
BLDC	BLDC	BLDC	BLDC
42 / 39 / 37	48 / 46 / 44	52 / 51 / 48	52 / 51 / 48
42 / 39 / 37	48 / 46 / 44	52 / 51 / 48	52 / 51 / 48
Fuse	Fuse	Fuse	Fuse

Notes

- Cooling<sup>1</sup> : Indoor Temperature 27°C (80.6°F) DB / 19°C (66.2°F) WB, Outdoor Temperature 35°C (95°F) DB / 24°C (75.2°F) WB
- Cooling<sup>2</sup> : Indoor Temperature 29°C (84.2°F) DB / 19°C (66.2°F) WB, Outdoor Temperature 46°C (114.8°F) DB / 24°C (75.2°F) WB
- Heating Temperature : Indoor 20°C (68°F) DB / 15°C (59°F) WB, Outdoor 7°C (44.6°F) DB / 6°C (42.8°F) WB

# SPECIFICATIONS

## CEILING MOUNTED CASSETTE - STANDARD



**COOL**

Combination	Outdoor unit		Unit	ATUQ22GPLA4	ATUQ30GPLA4
	Indoor unit			ATNQ22GPLA4	ATNQ30GPLA4
Capacity	Cooling	Min. - Rated - Max.	kW	1.58 - 5.13 - 6.45	2.11 - 7.03 - 8.79
			Btu/h	5,400 - 17,500 - 22,000	7,200 - 24,000 - 30,000
Power Input	Cooling	Rated	kW	1.51	2.19
Running Current	Cooling	Rated	A	6.60	9.60
EER / COP			Btu / hW / W	11.59 / 3.40	10.96 / 3.21
SEER / SCOP			Wh / Wh	19.00 / -	19.00 / -
<b>Outdoor</b>			<b>Wh / Wh</b>	<b>ATUQ22GPLA4</b>	<b>ATUQ30GPLA4</b>
Power Supply			V, ∅, Hz	220-240 / 50,60 / 1	220-240 / 50,60 / 1
Power Supply Cable (included Earth)			No. x mm <sup>2</sup>	3C x 2.5 (12)	3C x 2.5 (12)
Casing Color			-	Warm Gray	Warm Gray
Dimensions	Net	W x H x D	mm	770 x 545 x 288	870 x 650 x 330
Weight	Net		kg (lbs)	33.0 (72.8)	41.5 (91.5)
Compressor	Type		-	Twin Rotary	Twin Rotary
Fan Motor	Type			BLDC	BLDC
Sound Pressure Level	Cooling	Rated	dB(A)	47	53
Piping Connections	Liquid	Outer Dia.	mm (inch)	∅ 6.35 (1/4)	∅ 9.52 (3/8)
	Gas	Outer Dia.	mm (inch)	∅ 12.7 (1/2)	∅ 15.88 (5/8)
Piping Length	Max.		m (ft)	30 (98.4)	50 (164.0)
Maximum Height Difference (ODU - IDU)	Max.		m (ft)	20 (65.6)	30 (98.4)
<b>Indoor</b>			<b>Unit</b>	<b>ATNQ22GPLA4</b>	<b>ATNQ30GPLA4</b>
Power Supply			V, ∅, Hz	220-240, 1, 50	220-240, 1, 50
Dimensions	Net	W x H x D	mm	840 x 204 x 840	840 x 204 x 840
	Shipping	W x H x D	mm	922 x 276 x 917	922 x 276 x 917
Weight	Net		kg	21 (46.3)	21 (46.3)
	Shipping		kg	27 (59.5)	27 (59.5)
Air Flow Rate	H / M / L		m <sup>3</sup> /min	16.5 / 14.5 / 13.0	17.0 / 15.0 / 13.0
Fan Motor	Type			BLDC	BLDC
Protection Device				Fuse	Fuse
Sound Pressure Level	H / M / L		dB(A)	36 / 34 / 32	38 / 36 / 34



**COOL**

AUUQ40GH4	AUUQ50GH4	AUUQ60GH4
ATNQ40GNLA4	ATNQ50GMLA4	ATNQ60GMLA4
3.15 - 9.99 - 11.55	4.05 - 12.9 - 14.5	4.05 - 17.00 - 17.88
10,800 - 34,100 - 39,400	13,800 - 44,000 - 49,500	13,800 - 58,000 - 61,000
3.00	4.53	5.85
13.20	19.90	25.70
11.37 / 3.33	9.71 / 2.85	9.91 / 2.91
19.00 / -	18.00 / -	18.00 / -
<b>AUUQ40GH4</b>	<b>AUUQ50GH4</b>	<b>AUUQ60GH4</b>
220-240 / 50,60 / 1	220-240 / 50,60 / 1	220-240 / 50,60 / 1
3C x 2.5 (12)	3C x 4.0 (10)	3C x 6.0 (6)
Warm Gray	Warm Gray	Warm Gray
950 x 834 x 330	950 x 834 x 330	950 x 1,380 x 330
56.0 (123.5)	67 (147.7)	96.0 (211.6)
Twin Rotary	Twin Rotary	LG Inverter Scroll
BLDC	BLDC	BLDC
55	57	59
∅ 9.52 (3/8)	∅ 9.52 (3/8)	∅ 9.52 (3/8)
∅ 15.88 (5/8)	∅ 15.88 (5/8)	∅ 19.05 (3/4)
50 (164.0)	50 (164.0)	50 (164.0)
30 (98.4)	30 (98.4)	30 (98.4)
<b>ATNQ40GNLA4</b>	<b>ATNQ50GMLA4</b>	<b>ATNQ60GMLA4</b>
220-240, 1, 50	220-240, 1, 50	220-240, 1, 50
840 x 246 x 840	840 x 288 x 840	840 x 288 x 840
922 x 318 x 917	922 x 360 x 917	922 x 360 x 917
24 (52.9)	28 (61.7)	28 (61.7)
30(66.1)	34 (80.0)	34 (80.0)
23.0 / 21.0 / 19.0	31.0 / 28.0 / 25	31.0 / 28.0 / 25
BLDC	BLDC	BLDC
Fuse	Fuse	Fuse
40 / 38 / 36	47 / 45 / 42	47 / 45 / 42

# CEILING CONCEALED DUCT



## E.S.P. (EXTERNAL STATIC PRESSURE) CONTROL

This function easily controls volume of the air by a remote controller. The BLDC motor can control fan speed and air volume regardless of the external static pressure. Additional accessories are not required to control air flow.

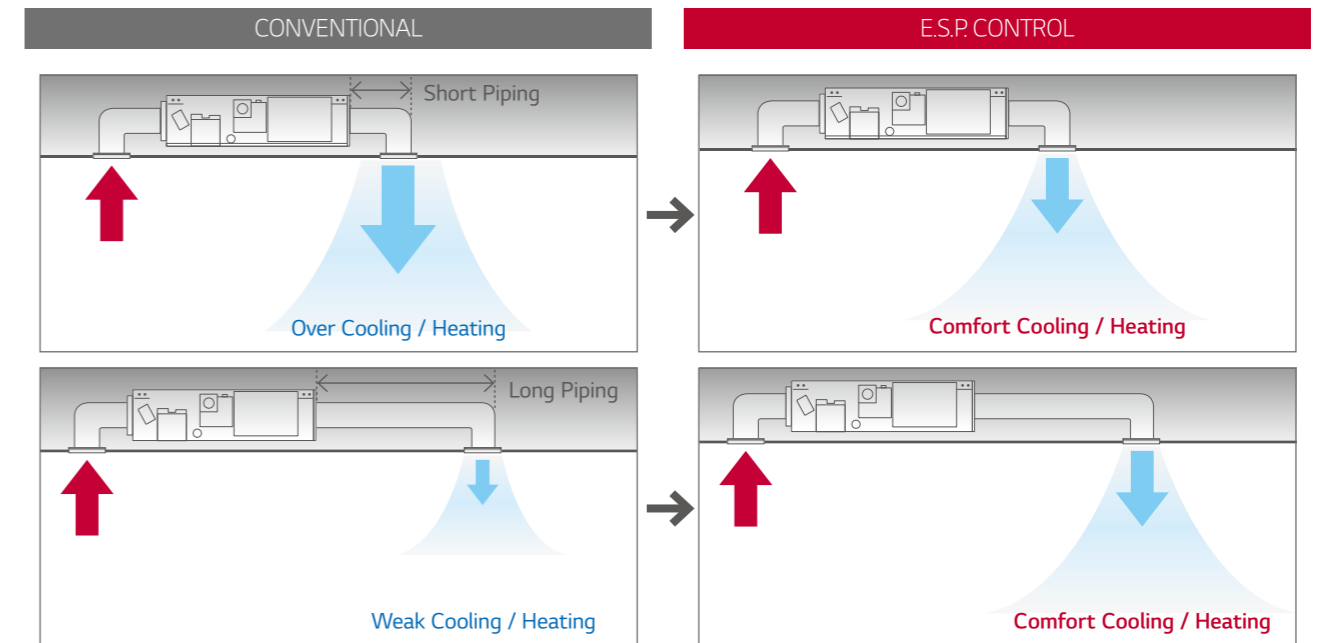

## MAXIMIZED E.S.P. (EXTERNAL STATIC PRESSURE)

With new indoor tool, connectable duct length is more longer than current running unit because the maximum E.S.P. is improved. Noise level also decreased about 14%

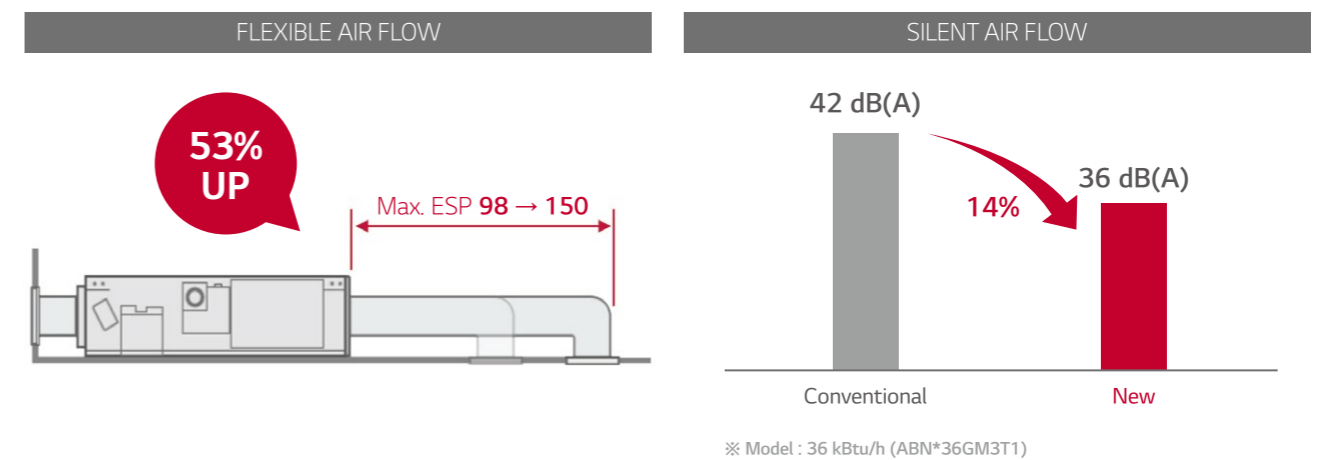

DUCT



# CEILING CONCEALED DUCT

## MINIMIZED HEIGHT

New mid-static ducts provide ideal solution for installation in limited space.

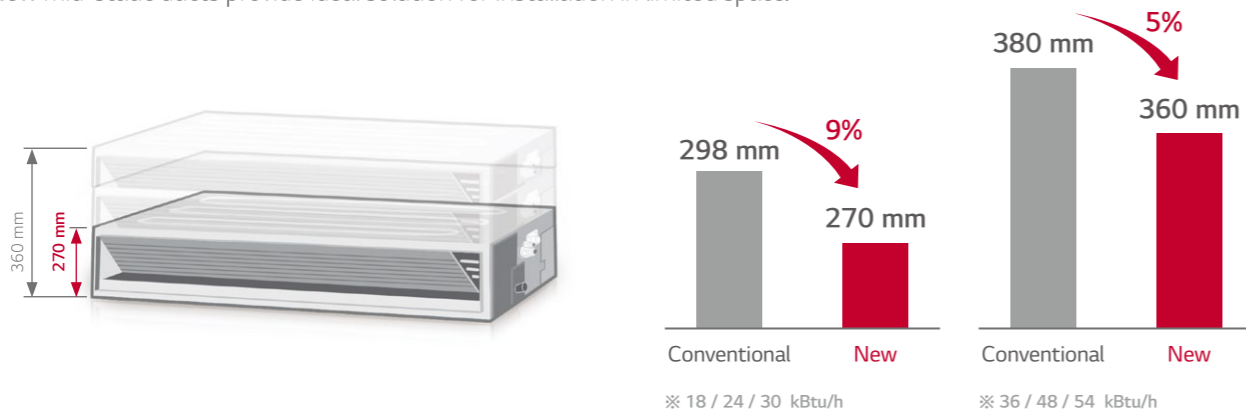

## TWO THERMISTORS CONTROL

The indoor temperature can be measured using the thermistors in the remote controller as well as in the indoor unit. There may be a significant difference between ceiling and floor air temperature. Two thermistors can optimise indoor air temperature for a more comfortable environment.

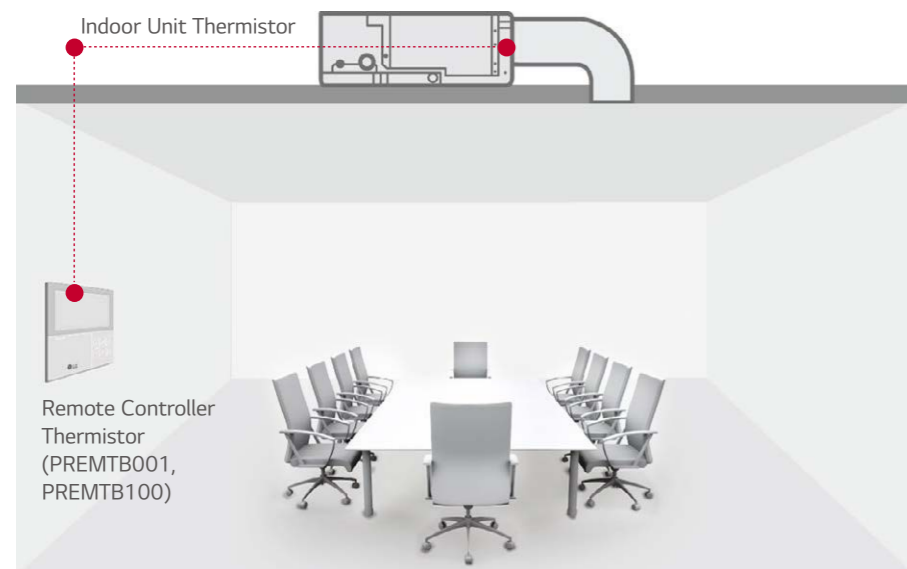

Compares temperatures sensed from different positions, and automatically selects the optimum temperature for users

## OPERATION FOR MULTIPLE ROOMS

Using a spiral duct (Embedded or flexible type) and stream chamber, it is possible to operate cooling / heating for several rooms simultaneously. Also, zone control is available with zone controller accessory (ABZCA)

### Zone control features

- Controls different zones (up to 4 zones) by external thermostat (AC 24V)
- Maintain proper air volume of each zone
- Auto variation of dampers
- Auto control of fan speed and On / Off operation

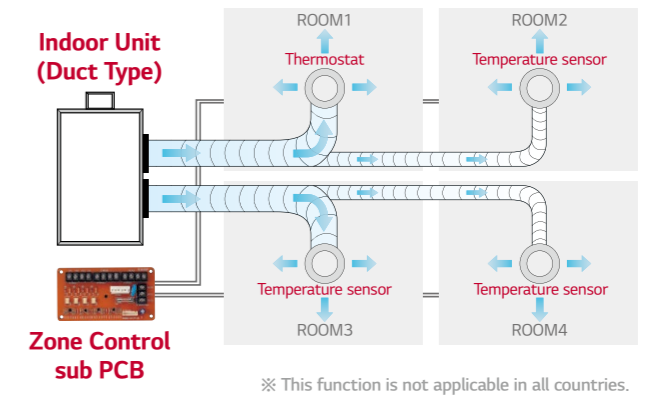

## HIGH HEAD DRAIN PUMP

High head drain pump automatically drains water up to a height of 200mm of drain-head height. It provides the perfect solution for draining of water. (Standard Inverter : Accessory (ABDPG) / Low-Static Duct : Included)

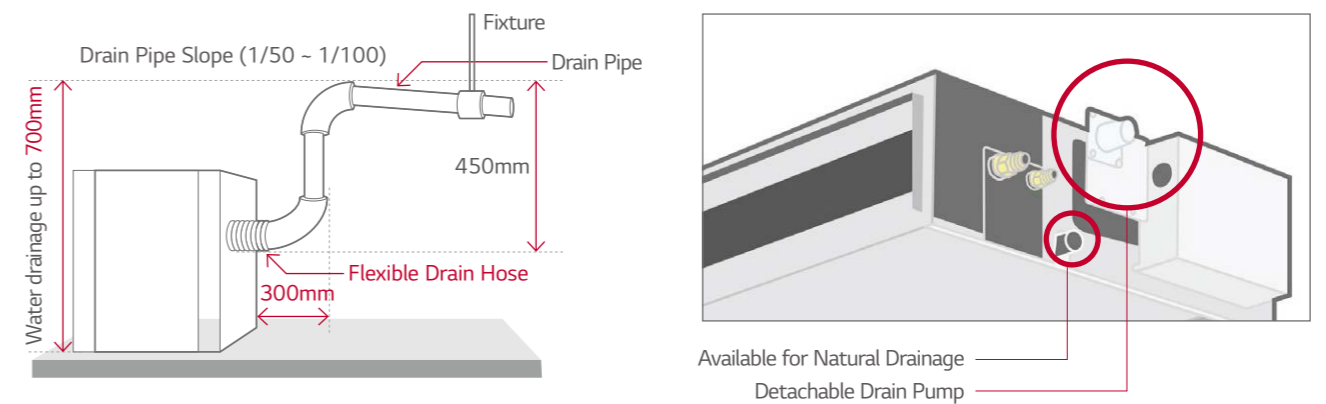

## EASY SERVICE & MAINTENANCE

Users are not required to disassemble the whole panel for maintenance, since panel is divided into 2 components; one for heat exchanger and the other for fan/motor. Users can easily detach and re-attach the filter in the available limited space.

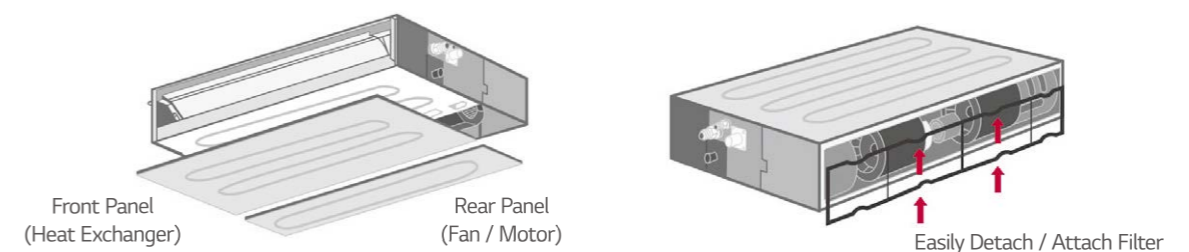

# SPECIFICATIONS

## CEILING CONCEALED DUCT - HIGH EFFICIENCY



### TROPICAL HEAT

Combination	Outdoor unit		Unit	ABUW18GM1T1	ABUW24GM1T1
	Indoor unit			ABNW18GM1T1	ABNW24GM1T1
Cooling Capacity <sup>1)</sup>	Min. - Rated - Max.		kW	2.1-5.27-5.86	2.81-7.03-7.91
			Btu/h	7,200-18,000-20,000	9,600-24,000-27,000
Cooling Capacity <sup>2)</sup>	Min. - Rated - Max.		kW	4.53	5.86
			Btu/h	15,480	20,000
Heating Capacity <sup>1)</sup>	Min. - Rated - Max.		kW	2.1-5.27-6.1	2.8-7.03-8.2
			Btu/h	7,200-18,000-21,000	9,600-24,000-28,000
Power Input	Cooling <sup>1)</sup>	Rated	kW	1.55	2.06
	Cooling <sup>2)</sup>	Rated	kW	1.72	2.32
	Heating <sup>1)</sup>	Rated	kW	1.50	2.05
EER / COP			W/W	3.4/3.51	3.41/3.43
<b>Outdoor</b>			<b>Unit</b>	<b>ABUW18GM1T1</b>	<b>ABUW24GM1T1</b>
Power Supply			V, Ø, Hz	220-240, 1, 50	220-240, 1, 50
Power Supply Cable (included Earth)			No. x mm <sup>2</sup>	3C x 2.5	3C x 2.5
Casing Color			-	Warm Gray	Warm Gray
Dimensions	Net	W x H x D	mm	770 x 545 x 288	870 x 650 x 330
Weight	Net		kg	35.2	45.5
Compressor	Type		-	Twin Rotary	Twin Rotary
Refrigerant	Type		-	R410A	R410A
Fan	Air Flow Rate	Rated	m <sup>3</sup> /min x No.	28 x 1	50 x 1
Fan Motor	Type		-	BLDC	BLDC
Sound Pressure Level	Cooling	Rated	dB(A)	49	50
	Heating	Rated	dB(A)	52	52
Piping Connections	Liquid	Outer Dia.	mm (inch)	Ø 6.35 (1/4)	Ø 9.52 (3/8)
	Gas	Outer Dia.	mm (inch)	Ø 12.7 (1/2)	Ø 15.88 (5/8)
Piping Length	Rated		m	5	5
	Max.		m	30	50
Maximum Height Difference (ODU - IDU)	Max.		m	15	30
<b>Indoor</b>			<b>Unit</b>	<b>ABNW18GM1T1</b>	<b>ABNW24GM1T1</b>
Type			-	Ceiling Concealed Duct-Mid. Pressure	
Power Supply			V, Ø, Hz	220-240, 1, 50	220-240, 1, 50
Dimensions	Net	W x H x D	mm	900 x 270 x 700	900 x 270 x 700
Weight	Net		kg	23.8	25.3
Air Flow Rate	H / M / L		m <sup>3</sup> /min	16.5 / 14.5 / 13.0	18.0 / 16.5 / 14.5
	Max		m <sup>3</sup> /min	23.8	23.8
Fan Motor	Type		-	6	6
External static pressure	High Mode_Factory Set		Pa (mmAq)	BLDC	BLDC
Safety Device			-	Fuse	Fuse
Sound Pressure Level	H / M / L		dB(A)	34 / 32 / 30	37 / 35 / 32

Notes

- Cooling<sup>1)</sup> : Indoor Temperature 27°C (80.6°F) DB / 19°C (66.2°F) WB, Outdoor Temperature 35°C (95°F) DB / 24°C (75.2°F) WB
- Cooling<sup>2)</sup> : Indoor Temperature 29°C (84.2°F) DB / 19°C (66.2°F) WB, Outdoor Temperature 46°C (114.8°F) DB / 24°C (75.2°F) WB
- Heating Temperature : Indoor 20°C (68°F) DB / 15°C (59°F) WB, Outdoor 7°C (44.6°F) DB / 6°C (42.8°F) WB

### TROPICAL HEAT

ABUW30GM1T1	ABUW36GM3T1	ABUW48GM3T1	ABUW54GM3T1
ABNW30GM1T1	ABNW36GM3T1	ABNW48GM3T1	ABNW54GM3T1
3.36-8.2-9.96	4.7-9.99-11.13	5.39-13.48-15.53	6.33-15.82-16.7
11,480-28,000-34,000	16,030-34,100-38,000	18,400-46,000-53,000	21,600-54,000-57,000
7.05	8.49	11.59	12.66
24,080	28,980	39,560	43,200
3.28-8.2-9.09	3.75-9.38-10.26	5.62-14.06-15.8	6.56-16.41-17.6
11,200-28,000-31,000	12,800-32,000-35,000	19,200-48,000-54,000	22,400-56,000-60,000
2.41	2.93	3.96	5.39
2.74	3.24	4.27	5.07
2.55	2.46	4.00	4.61
3.4/3.22	3.41/3.81	3.4/3.52	2.94/3.56
<b>ABUW30GM1T1</b>		<b>ABUW36GM3T1</b>	
220-240, 1, 50		220-240, 1, 50	
3C x 2.5		3C x 2.5	
Warm Gray		Warm Gray	
950 x 834 x 330		950 x 834 x 330	
60.8		60.8	
Twin Rotary		Twin Rotary	
R410A		R410A	
60 x 1		60 x 1	
BLDC		BLDC	
51		51	
53		53	
Ø 9.52 (3/8)		Ø 9.52 (3/8)	
Ø 15.88 (5/8)		Ø 15.88 (5/8)	
5		5	
50		50	
30		30	
<b>ABNW30GM1T1</b>		<b>ABNW36GM3T1</b>	
220-240, 1, 50		220-240, 1, 50	
900 x 270 x 700		1,250 x 360 x 700	
25.3		37.5	
22.0 / 20.0 / 18.0		30.0 / 25.0 / 20.0	
25.9		41.0	
6		6	
BLDC		BLDC	
Fuse		Fuse	
37 / 35 / 34		36 / 33 / 31	
<b>ABNW48GM3T1</b>		<b>ABNW54GM3T1</b>	
220-240, 1, 50		220-240, 1, 50	
1,250 x 360 x 700		1,250 x 360 x 700	
43.5		43.5	
40.0 / 34.0 / 28.0		50.0 / 45.0 / 40.0	
58.8		58.8	
6		6	
BLDC		BLDC	
Fuse		Fuse	
38 / 36 / 34		46 / 44 / 42	

# SPECIFICATIONS

## CEILING CONCEALED DUCT - HIGH EFFICIENCY



**TROPICAL COOL**

Combination	Outdoor unit		Unit	ABUQ18GM1T1	ABUQ24GM1T1
	Indoor unit			ABNQ18GM1T1	ABNQ24GM1T1
Cooling Capacity <sup>1)</sup>	Min. - Rated - Max.		kW	2.1-5.27-5.86	2.81-7.03-7.91
			Btu/h	7,200-18,000-20,000	9,600-24,000-27,000
Cooling Capacity <sup>2)</sup>	Min. - Rated - Max.		kW	4.53	5.86
			Btu/h	15,480	20,000
Power Input	Cooling <sup>1)</sup>	Rated	kW	1.55	2.06
	Cooling <sup>2)</sup>	Rated	kW	1.72	2.32
EER / COP			W/W	3.4	3.41
<b>Outdoor</b>			<b>Unit</b>	<b>ABUQ18GM1T1</b>	<b>ABUQ24GM1T1</b>
Power Supply			V, ∅, Hz	220-240, 1, 50	220-240, 1, 50
Power Supply Cable (included Earth)			No. × mm <sup>2</sup>	3C × 2.5	3C × 2.5
Casing Color			-	Warm Gray	Warm Gray
Dimensions	Net	W × H × D	mm	770 × 545 × 288	870 × 650 × 330
Weight	Net		kg	34.3	43.3
Compressor	Type		-	Twin Rotary	Twin Rotary
Refrigerant	Type		-	R410A	R410A
Fan Motor	Type		-	BLDC	BLDC
Sound Pressure Level	Cooling	Rated	dB(A)	49	50
Piping Connections	Liquid	Outer Dia.	mm (inch)	∅ 6.35 (1/4)	∅ 9.52 (3/8)
	Gas	Outer Dia.	mm (inch)	∅ 12.7 (1/2)	∅ 15.88 (5/8)
Piping Length		Rated	m	5	5
		Max.	m	30	50
Maximum Height Difference (ODU - IDU)		Max.	m	15	30
<b>Indoor</b>			<b>Unit</b>	<b>ABNQ18GM1T1</b>	<b>ABNQ24GM1T1</b>
Type			-	Ceiling Concealed Duct-Mid. Pressure	
Power Supply			V, ∅, Hz	220-240, 1, 50	220-240, 1, 50
Dimensions	Net	W × H × D	mm	900 × 270 × 700	900 × 270 × 700
Weight	Net		kg	23.8	25.3
Air Flow Rate		H / M / L	m <sup>3</sup> /min	16.5 / 14.5 / 13.0	18.0 / 16.5 / 14.5
		Max.	m <sup>3</sup> /min	23.8	23.8
External static pressure	High Mode_Factory Set		Pa (mmAq)	6	6
Fan Motor	Type		-	BLDC	BLDC
Safety Device			-	Fuse	Fuse
Sound Pressure Level		H / M / L	dB(A)	34 / 32 / 30	37 / 35 / 32

**Notes**

- Cooling<sup>1)</sup> : Indoor Temperature 27°C (80.6°F) DB / 19°C (66.2°F) WB, Outdoor Temperature 35°C (95°F) DB / 24°C (75.2°F) WB  
 - Cooling<sup>2)</sup> : Indoor Temperature 29°C (84.2°F) DB / 19°C (66.2°F) WB, Outdoor Temperature 46°C (114.8°F) DB / 24°C (75.2°F) WB

**TROPICAL COOL**

ABUQ30GM1T1	ABUQ36GM3T1	ABUQ48GM3T1	ABUQ54GM3T1
ABNQ30GM1T1	ABNQ36GM3T1	ABNQ48GM3T1	ABNQ54GM3T1
3.36-8.2-9.96	4.7-9.99-11.13	5.392-13.48-15.53	6.328-15.82-16.7
11,480-28,000-34,000	16,030-34,100-38,000	18,400-46,000-53,000	21,600-54,000-57,000
7.05	8.49	11.59	12.66
24,080	28,980	39,560	43,200
2.41	2.93	3.96	5.39
2.74	3.24	4.27	5.07
3.4	3.41	3.4	2.94
<b>ABUQ30GM1T1</b>	<b>ABUQ36GM3T1</b>	<b>ABUQ48GM3T1</b>	<b>ABUQ54GM3T1</b>
220-240, 1, 50	220-240, 1, 50	220-240, 1, 50	220-240, 1, 50
3C × 2.5	3C × 2.5	3C × 6.0	3C × 6.0
Warm Gray	Warm Gray	Warm Gray	Warm Gray
950 × 834 × 330	950 × 834 × 330	950 × 1,380 × 330	950 × 1,380 × 330
59.1	59.1	89.5	89.5
Twin Rotary	Twin Rotary	LG Inverter Scroll	LG Inverter Scroll
R410A	R410A	R410A	R410A
BLDC	BLDC	BLDC	BLDC
51	51	55	55
∅ 9.52 (3/8)	∅ 9.52 (3/8)	∅ 9.52 (3/8)	∅ 9.52 (3/8)
∅ 15.88 (5/8)	∅ 15.88 (5/8)	∅ 19.05 (3/4)	∅ 19.05 (3/4)
5	5	5	5
50	50	75	75
30	30	30	30
<b>ABNQ30GM1T1</b>	<b>ABNQ36GM3T1</b>	<b>ABNQ48GM3T1</b>	<b>ABNQ54GM3T1</b>
Ceiling Concealed Duct-Mid. Pressure			
220-240, 1, 50	220-240, 1, 50	220-240, 1, 50	220-240, 1, 50
900 × 270 × 700	1,250 × 360 × 700	1,250 × 360 × 700	1,250 × 360 × 700
25.3	37.5	43.5	43.5
22.0 / 20.0 / 18.0	30.0 / 25.0 / 20.0	40.0 / 34.0 / 28.0	50.0 / 45.0 / 40.0
25.9	41.0	58.8	58.8
6	6	6	6
BLDC	BLDC	BLDC	BLDC
Fuse	Fuse	Fuse	Fuse
37 / 35 / 34	36 / 33 / 31	38 / 36 / 34	46 / 44 / 42

# SPECIFICATIONS

## CEILING CONCEALED DUCT - STANDARD



### TROPICAL HEAT

Combination	Outdoor unit		Unit	ABUW18GM1S1	ABUW24GM1S1
	Indoor unit			ABNW18GM1S1	ABNW24GM1S1
Cooling Capacity <sup>1)</sup>	Min. - Rated - Max.		kW	1.8 - 5.2 - 5.5	2.8 - 7.0 - 8.1
			Btu/h	6,100 - 17,700 - 18,800	9,600 - 23,900 - 27,600
Cooling Capacity <sup>2)</sup>	Min. - Rated - Max.		kW	4.20	5.75
			Btu/h	14,300	19,600
Heating Capacity <sup>1)</sup>	Min. - Rated - Max.		kW	1.9 - 5.3 - 6.1	3.0 - 7.6 - 8.7
			Btu/h	6,500 - 18,100 - 20,800	10,200 - 25,900 - 29,700
Power Input	Cooling <sup>1)</sup>	Rated	kW	1700	2325
	Cooling <sup>2)</sup>	Rated	kW	1750	2650
	Heating <sup>1)</sup>	Rated	kW	1650	2300
EER / COP			W/W	3.06 / 3.21	3.01 / 3.30
<b>Outdoor</b>			<b>Unit</b>	<b>ABUW18GM1S1</b>	<b>ABUW24GM1S1</b>
Power Supply	V, Ø, Hz			220-240, 1, 50	220-240, 1, 50
Power Supply Cable (included Earth)	No. x mm <sup>2</sup>			3C x 2.5 (12)	3C x 2.5 (12)
Casing Color				Warm Gray	Warm Gray
Dimensions	Net	W x H x D	mm	770 x 545 x 288	870 x 650 x 330
Weight	Net		kg	35.5 (78.3)	44.8 (98.8)
Compressor	Type			Twin Rotary	Twin Rotary
Refrigerant	Type			R410A	R410A
Fan	Air Flow Rate	Rated	m <sup>3</sup> /min x No.	Propeller	Propeller
Fan Motor	Type			28 x 1	50 x 1
Sound Pressure Level	Cooling	Rated	dB(A)	BLDC	BLDC
	Heating	Rated	dB(A)	53	55
Piping Connections	Liquid	Outer Dia.	mm (inch)	54	56
	Gas	Outer Dia.	mm (inch)	Ø 6.35 (1/4)	Ø 9.52 (3/8)
Piping Length	Rated		m	Ø 12.7 (1/2)	Ø 15.88 (5/8)
	Max.		m	25 (82.0)	30 (98.4)
Maximum Height Difference (ODU - IDU)	Max.		m	15 (49.2)	30 (98.4)
<b>Indoor</b>			<b>Unit</b>	<b>ABNW18GM1S1</b>	<b>ABNW24GM1S1</b>
Type				Ceiling Concealed Duct-Mid. Pressure	
Power Supply	V, Ø, Hz			220-240, 1, 50	220-240, 1, 50
Dimensions	Net	W x H x D	mm	900 x 270 x 700	900 x 270 x 700
Weight	Net		kg	23.8 (52.5)	24.2 (53.4)
Fan Motor	Type			BLDC	BLDC
External static pressure	High Mode_Factory Set		Pa (mmAq)	58.8 (6)	58.8 (6)
Safety Device				Fuse	Fuse
Sound Pressure Level	Cooling	H / M / L	dB(A)	36 / 34 / 32	37 / 36 / 34
	Heating			36 / 34 / 32	37 / 36 / 34

Notes

- Cooling<sup>1)</sup> : Indoor Temperature 27°C (80.6°F) DB / 19°C (66.2°F) WB, Outdoor Temperature 35°C (95°F) DB / 24°C (75.2°F) WB
- Cooling<sup>2)</sup> : Indoor Temperature 29°C (84.2°F) DB / 19°C (66.2°F) WB, Outdoor Temperature 46°C (114.8°F) DB / 24°C (75.2°F) WB
- Heating Temperature : Indoor 20°C (68°F) DB / 15°C (59°F) WB, Outdoor 7°C (44.6°F) DB / 6°C (42.8°F) WB

### TROPICAL HEAT

ABUW30GM1S1	ABUW36GM2S1	ABUW48GM3S1	ABUW54GM3S1
ABNW30GM1S1	ABNW36GM2S1	ABNW48GM3S1	ABNW54GM3S1
30 - 78 - 85	36 - 9.5 - 10.5	56 - 14.1 - 15.1	6.3 - 15.6 - 16.8
10,200 - 26,600 - 29,000	12,300 - 32,400 - 35,800	19,100 - 48,100 - 51,500	21,500 - 53,200 - 57,300
6.50	7.80	12.00	13.40
22,200	26,600	40,900	45,700
3.2 - 8.0 - 9.0	4.0 - 10.5 - 11.5	6.3 - 15.8 - 16.8	6.8 - 17 - 18.2
10,900 - 28,700 - 30,700	13,600 - 35,800 - 39,200	21,500 - 53,900 - 57,300	23,200 - 58,000 - 62,100
2590	3155	4390	5190
3150	3160	4850	5690
2650	3080	4630	4860
3.01 / 3.01	3.01 / 3.41	3.21 / 3.41	3.01 / 3.50
<b>ABUW30GM1S1</b>	<b>ABUW36GM2S1</b>	<b>ABUW48GM3S1</b>	<b>ABUW54GM3S1</b>
220-240, 1, 50	220-240, 1, 50	220-240, 1, 50	380-415, 3, 50
3C x 2.5 (12)	3C x 2.5 (12)	3C x 6.0 (10)	5C x 2.5 (12)
Warm Gray	Warm Gray	Warm Gray	Warm Gray
870 x 650 x 330	950 x 834 x 330	950 x 1,380 x 330	950 x 1,380 x 330
44.8 (98.8)	58.0 (127.9)	90.0 (198.4)	90.0 (198.4)
Twin Rotary	Twin Rotary	Twin Rotary	Twin Rotary
R410A	R410A	R410A	R410A
Propeller	Propeller	Propeller	Propeller
50 x 1	58 x 1	58 x 2	58 x 2
BLDC	BLDC	BLDC	BLDC
55	56	55	55
56	58	57	57
Ø 9.52 (3/8)	Ø 9.52 (3/8)	Ø 9.52 (3/8)	Ø 9.52 (3/8)
Ø 15.88 (5/8)	Ø 15.88 (5/8)	Ø 19.05 (3/4)	Ø 19.05 (3/4)
30 (98.4)	40 (131.2)	50 (164.0)	50 (164.0)
30 (98.4)	30 (98.4)	30 (98.4)	30 (98.4)
<b>ABNW30GM1S1</b>	<b>ABNW36GM2S1</b>	<b>ABNW48GM3S1</b>	<b>ABNW54GM3S1</b>
Ceiling Concealed Duct-Mid. Pressure			
220-240, 1, 50	220-240, 1, 50	220-240, 1, 50	220-240, 1, 50
900 x 270 x 700	1,250 x 270 x 700	1,250 x 360 x 700	1,250 x 360 x 700
25.3 (55.8)	36.0 (79.4)	42.3 (93.3)	42.3 (93.3)
BLDC	BLDC	BLDC	BLDC
58.8 (6)	58.8 (6)	58.8 (6)	58.8 (6)
Fuse	Fuse	Fuse	Fuse
39 / 37 / 36	38 / 36 / 35	41 / 39 / 37	44 / 42 / 41
39 / 37 / 36	38 / 36 / 35	41 / 39 / 37	44 / 42 / 41

Notes

- Cooling<sup>1)</sup> : Indoor Temperature 27°C (80.6°F) DB / 19°C (66.2°F) WB, Outdoor Temperature 35°C (95°F) DB / 24°C (75.2°F) WB
- Cooling<sup>2)</sup> : Indoor Temperature 29°C (84.2°F) DB / 19°C (66.2°F) WB, Outdoor Temperature 46°C (114.8°F) DB / 24°C (75.2°F) WB
- Heating Temperature : Indoor 20°C (68°F) DB / 15°C (59°F) WB, Outdoor 7°C (44.6°F) DB / 6°C (42.8°F) WB

# SPECIFICATIONS

## CEILING CONCEALED DUCT - STANDARD



ABUW12GL5S1



ABUQ22GM1A4

ABUQ30GM1A4

AUUQ40GH4

AUUQ50GH4  
AUUQ60GH4

**HEAT**

Combination	Outdoor unit		Unit	ABUW12GL5S1
	Indoor unit			ABNW12GL5S1
Capacity	Cooling <sup>1)</sup>	Min. - Rated - Max.	kW	1.35 - 3.50 - 3.65
		Min. - Rated - Max.	Btu/h	4,607 - 11,944 - 12,456
	Heating	Min. - Rated - Max.	kW	1.39 - 4.00 - 4.47
		Min. - Rated - Max.	Btu/h	4,743 - 13,650 - 15,254
Power Input	Cooling <sup>1)</sup>	Rated	kW	1.17
	Heating <sup>1)</sup>	Rated	kW	1.20
EER / COP	Cooling <sup>1)</sup> / Heating		W/W	3.00 / 3.33
<b>Outdoor</b>			<b>Unit</b>	<b>ABUW12GL5S1</b>
Power Supply			V, ∅, Hz	220-240 / 1 / 50
Power Supply Cable (included Earth)			No. x mm <sup>2</sup>	3C x 2.5 (12)
Casing Color			-	Warm Gray
Dimensions	Net	W x H x D	mm	717 x 230 x 483
Net Weight			kg	26
Compressor	Type			Twin Rotary
Refrigerant	Type			R410A
Fan	Air Flow Rate	Rated	m <sup>3</sup> /min x No.	27 x 1
Fan Motor	Type			AC
Sound Pressure Level	Cooling	Rated	dB(A)	52
	Heating	Rated	dB(A)	52
Piping Connections	Liquid	Outer Dia.	mm (inch)	∅ 6.35 (1/4)
	Gas	Outer Dia.	mm (inch)	∅ 9.52 (3/8)
Piping Length			Max.	15
Maximum Height Difference (ODU - IDU)			Max.	7.5
<b>Indoor</b>			<b>Unit</b>	<b>ABNW12GL5S1</b>
Power Supply			V, ∅, Hz	220-240, 1, 50
Dimensions	Net	W x H x D	mm	900 x 190 x 460
Net Weight			kg	18
Fan	Air Flow Rate	H / M / L	m <sup>3</sup> /min	11.5 / 9.5 / 8
Fan Motor	Type			DC
External static pressure	High Mode_Factory Set		-	10
Sound Pressure Level	Cooling	Rated	dB(A)	36 / 33 / 31
	Heating	Rated	dB(A)	36 / 33 / 31

Notes

- Cooling<sup>1)</sup> : Indoor Temperature 27°C (80.6°F) DB / 19°C (66.2°F) WB, Outdoor Temperature 35°C (95°F) DB / 24°C (75.2°F) WB  
 - Cooling<sup>2)</sup> : Indoor Temperature 29°C (84.2°F) DB / 19°C (66.2°F) WB, Outdoor Temperature 46°C (114.8°F) DB / 24°C (75.2°F) WB  
 - Heating Temperature : Indoor 20°C (68°F) DB / 15°C (59°F) WB, Outdoor 7°C (44.6°F) DB / 6°C (42.8°F) WB

**COOL**

Combination	Outdoor unit		Unit	ABUQ22GM1A4	ABUQ30GM1A4	AUUQ40GH4	AUUQ50GH4	AUUQ60GH4
	Indoor unit			ABNQ22GM1A4	ABNQ30GM1A4	ABNQ40GM3A4	ABNQ50GM3A4	ABNQ60GM3A4
Capacity	Cooling <sup>1)</sup>	Min. - Rated - Max.	kW	1.58 - 5.00 - 6.45	2.11 - 7.18 - 8.79	3.15 - 9.99 - 11.55	4.05 - 12.9 - 14.5	4.05 - 17.61 - 17.88
		Min. - Rated - Max.	Btu/h	5,400 - 17,060 - 22,000	7,200 - 24,500 - 30,000	10,800 - 34,100 - 39,400	13,800 - 44,000 - 49,500	13,800 - 60,100 - 61,000
Power Input	Cooling <sup>1)</sup>	Rated	kW	1.59	2.05	3.05	4.53	5.85
Running Current	Cooling <sup>1)</sup>	Rated	A	7.00	9.00	13.40	19.90	25.70
EER / COP			Btu / hW / W / W	10.73 / 3.14	11.95 / 3.50	11.18 / 3.28	9.71 / 2.85	10.27 / 3.01
SEER / SCOP			Wh / Wh	19.00 / -	19.00 / -	19.00 / -	18.00 / -	17.00 / -
<b>Outdoor</b>			<b>Unit</b>	<b>ABUQ22GM1A4</b>	<b>ABUQ30GM1A4</b>	<b>AUUQ40GH4</b>	<b>AUUQ50GH4</b>	<b>AUUQ60GH4</b>
Power Supply			V, ∅, Hz	220-240 / 1 / 50	220-240 / 1 / 50	220-240 / 1 / 50	220-240 / 1 / 50	220-240 / 1 / 50
Power Supply Cable (included Earth)			No. x mm <sup>2</sup>	3C x 2.5 (12)	3C x 2.5 (12)	3C x 2.5 (12)	3C x 2.5 (12)	3C x 2.5 (12)
Casing Color			-	Warm Gray	Warm Gray	Warm Gray	Warm Gray	Warm Gray
Dimensions	Net	W x H x D	mm	770 x 545 x 288	870 x 650 x 330	950 x 834 x 330	950 x 834 x 330	950 x 1,380 x 330
Net Weight			kg	33	41.5	56	67	96
Compressor	Type			Twin Rotary	Twin Rotary	LG Inverter Scroll	LG Inverter Scroll	LG Inverter Scroll
Refrigerant	Type			R410A	R410A	R410A	R410A	R410A
Fan	Air Flow Rate	Rated	m <sup>3</sup> /min x No.	50 x 1	50 x 1	70 x 1	70 x 1	70 x 2
Fan Motor	Type			BLDC	BLDC	BLDC	BLDC	BLDC
Sound Pressure Level	Cooling	Rated	dB(A)	47	53	55	57	59
Sound Power Level	Cooling	Rated	dB(A)	-	-	-	-	-
Piping Connections	Liquid	Outer Dia.	mm (inch)	∅ 6.35 (1/4)	∅ 9.52 (3/8)	∅ 9.52 (3/8)	∅ 9.52 (3/8)	∅ 9.52 (3/8)
	Gas	Outer Dia.	mm (inch)	∅ 12.7 (1/2)	∅ 15.88 (5/8)	∅ 15.88 (5/8)	∅ 15.88 (5/8)	∅ 19.05 (5/8)
Piping Length			Max.	5/30	5/50	5/50	5/50	5/50
Maximum Height Difference (ODU - IDU)			Max.	20	30	30	30	30
<b>Indoor</b>			<b>Unit</b>	<b>ABNQ22GM1A4</b>	<b>ABNQ30GM1A4</b>	<b>ABNQ40GM3A4</b>	<b>ABNQ50GM3A4</b>	<b>ABNQ60GM3A4</b>
Power Supply			V, ∅, Hz	220-240, 1, 50/60	220-240, 1, 50/60	220-240, 1, 50/60	220-240, 1, 50/60	220-240, 1, 50/60
Dimensions	Net	W x H x D	mm	900 x 270 x 700	900 x 270 x 700	1,250 x 360 x 700	1,250 x 360 x 700	1,250 x 360 x 700
Net Weight			kg	23.8	25.3	37.5	43.5	43.5
Fan	Air Flow Rate	H / M / L	m <sup>3</sup> /min	16.5 / 14.5 / 13.0	18.0 / 16.5 / 14.0	30.0 / 25.0 / 20.0	40.0 / 34.0 / 28.0	50.0 / 45.0 / 40.0
Fan Motor	Type			BLDC	BLDC	BLDC	BLDC	BLDC
External static pressure	Factory Set (Default)		mmAq	6	6	6	6	6
Sound Pressure Level	Cooling(H/M/L)	Rated	dB(A)	34 / 32 / 30	37 / 35 / 32	36 / 33 / 31	38 / 36 / 34	46 / 44 / 42

Notes

- Cooling<sup>1)</sup> : Indoor Temperature 27°C (80.6°F) DB / 19°C (66.2°F) WB, Outdoor Temperature 35°C (95°F) DB / 24°C (75.2°F) WB  
 - Cooling<sup>2)</sup> : Indoor Temperature 29°C (84.2°F) DB / 19°C (66.2°F) WB, Outdoor Temperature 46°C (114.8°F) DB / 24°C (75.2°F) WB  
 - Heating Temperature : Indoor 20°C (68°F) DB / 15°C (59°F) WB, Outdoor 7°C (44.6°F) DB / 6°C (42.8°F) WB

# CEILING SUSPENDED UNIT



## IF WINNING DESIGN

With its stunning V-shaped design and black vane, LG's new ceiling-suspended air conditioner exudes modern elegance which is appropriate for any space.

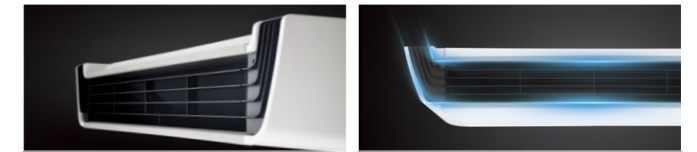

Black Vane

V-Shaped Design

## LARGE CAPACITY

An enlarged outlet space optimized the air flow path and improved heat exchanger's performance. Its 30 percent faster cooling enables quick & wide cooling.

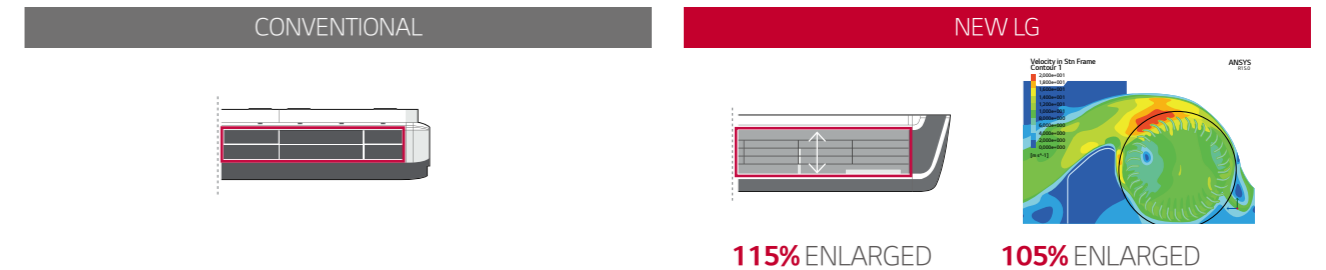

## 15m LONG AIR FLOW

The powerful air speed and high volume features enhance the flow of air, and it reaches up to 15m away from the air conditioner.



## ONE TOUCH FILTER CHANGING

An easy In / Out filter structure as well as a simplified two-piece filter, which slides out for easy cleaning and maintenance.

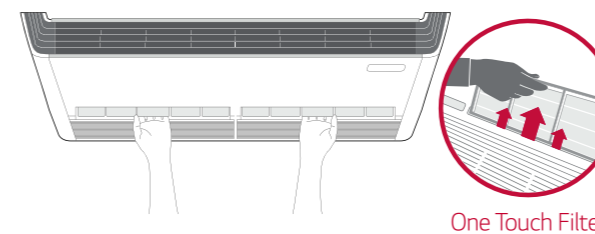

One Touch Filter

## EASY INSTALLATION

Installation speed and ease are improved by reducing the total number of screws and placing them on the easily accessible front panel.

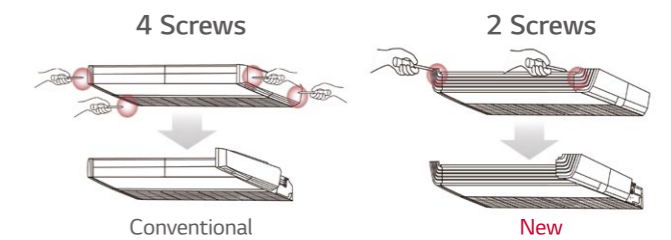

Conventional

New

# SPECIFICATIONS

## CEILING SUSPENDED UNIT - HIGH EFFICIENCY



### TROPICAL HEAT

Combination	Outdoor unit		Unit	AVUW18GM1T1	AVUW24GM1T1
	Indoor unit			AVNW18GM1T1	AVNW24GM1T1
Cooling Capacity <sup>1)</sup>	Min. - Rated - Max.		kW	2.1-5.27-5.86	2.81-7.03-7.91
			Btu/h	7,200-18,000-20,000	9,600-24,000-27,000
Cooling Capacity <sup>2)</sup>	Min. - Rated - Max.		kW	4.37	6.04
			Btu/h	14,900	20,610
Heating Capacity <sup>1)</sup>	Min. - Rated - Max.		kW	2.22-5.56-6.10	2.8-7.03-8.20
			Btu/h	7,600-19,000-21,000	9,600-24,000-28,000
Power Input	Cooling <sup>1)</sup>	Rated	kW	1.55	2.06
	Cooling <sup>2)</sup>	Rated	kW	1.73	2.38
	Heating <sup>1)</sup>	Rated	kW	1.62	2.05
EER / COP			W/W	3.40/3.43	3.41/3.43
<b>Outdoor</b>			<b>Unit</b>	<b>AVUW18GM1T1</b>	<b>AVUW24GM1T1</b>
Power Supply			V, Ø, Hz	220-240, 1, 50	220-240, 1, 50
Power Supply Cable (included Earth)			No. x mm <sup>2</sup>	3C x 2.5	3C x 2.5
Dimensions	Net	W x H x D	mm	770 x 545 x 288	870 x 650 x 330
Weight	Net		kg	35.2	45.5
Compressor	Type		-	Twin Rotary	Twin Rotary
Refrigerant	Type		-	R410A	R410A
Fan Motor	Type		-	BLDC	BLDC
Sound Pressure Level	Cooling	Rated	dB(A)	49	50
	Heating	Rated	dB(A)	52	52
Piping Connections	Liquid	Outer Dia.	mm (inch)	Ø 6.35(1/4)	Ø 9.52(3/8)
	Gas	Outer Dia.	mm (inch)	Ø 12.7(1/2)	Ø 15.88 (5/8)
Piping Length	Rated		m	5	5
	Min./Max.		m	5/30	5/50
Maximum Height Difference (ODU - IDU)	Max.		m	15	30
<b>Indoor</b>			<b>Unit</b>	<b>ABNW18GM1T1</b>	<b>ABNW24GM1T1</b>
Power Supply			V, Ø, Hz	220-240, 1, 50	220-240, 1, 50
Dimensions	Net	W x H x D	mm	1,200 x 235 x 690	1,200 x 235 x 690
Weight	Net		kg	27.3	28.0
Air Flow Rate		H / M / L	m <sup>3</sup> /min	13.0 / 12.0 / 11.0	16.5 / 15.0 / 14.0
Fan Motor	Type		-	BLDC	BLDC
Sound Pressure Level		H / M / L	dB(A)	40 / 38 / 37	44 / 43 / 41

Notes

- Cooling<sup>1)</sup> : Indoor Temperature 27°C (80.6°F) DB / 19°C (66.2°F) WB, Outdoor Temperature 35°C (95°F) DB / 24°C (75.2°F) WB
- Cooling<sup>2)</sup> : Indoor Temperature 29°C (84.2°F) DB / 19°C (66.2°F) WB, Outdoor Temperature 46°C (114.8°F) DB / 24°C (75.2°F) WB
- Heating Temperature : Indoor 20°C (68°F) DB / 15°C (59°F) WB, Outdoor 7°C (44.6°F) DB / 6°C (42.8°F) WB

### TROPICAL HEAT

AVUW30GM1T1	AVUW36GM2T1	AVUW48GM2T1	AVUW54GM2T1
AVNW30GM1T1	AVNW36GM2T1	AVNW48GM2T1	AVNW54GM2T1
3.36-8.2-10.26	4.46-9.49-11.13	5.39-13.48-15.53	6.33-15.82-16.70
11,480-28,000-35,000	15,230-32,400-38,000	18,400-46,000-53,000	21,600-54,000-57,000
7.05	8	11	13
24,080	27,860	35,880	43,200
3.28-8.2-9.09	3.8-9.49-10.84	5.62-14.06-15.80	6.56-16.41-17.60
11,200-28,000-31,000	12,960-32,400-37,000	19,200-48,000-54,000	22,400-56,000-60,000
2.41	2.80	4.00	5.40
2.85	3.23	4.10	5.00
2.33	2.70	4.00	5.10
3.40/3.52	3.40/3.51	3.40/3.52	2.94/3.22
<b>AVUW30GM1T1</b>	<b>AVUW36GM2T1</b>	<b>AVUW48GM2T1</b>	<b>AVUW54GM2T1</b>
220-240, 1, 50	220-240, 1, 50	220-240, 1, 50	220-240, 1, 50
3C x 2.5	3C x 2.5	3C x 6.0	3C x 6.0
950 x 834 x 330	950 x 834 x 330	950 x 1,380 x 330	950 x 1,380 x 330
60.8	60.8	90.2	90.2
Twin Rotary	Twin Rotary	LG Inverter Scroll	LG Inverter Scroll
R410A	R410A	R410A	R410A
BLDC	BLDC	BLDC	BLDC
51	51	55	55
53	53	57	57
Ø 9.52(3/8)	Ø 9.52(3/8)	Ø 9.52 (3/8)	Ø 9.52 (3/8)
Ø 15.88 (5/8)	Ø 15.88 (5/8)	Ø 19.05 (3/4)	Ø 19.05 (3/4)
5	5	5	5
5/50	5/50	5/75	5/75
30	30	30	30
<b>AVNW30GM1T1</b>	<b>AVNW36GM2T1</b>	<b>AVNW48GM2T1</b>	<b>AVNW54GM2T1</b>
220-240, 1, 50	220-240, 1, 50	220-240, 1, 50	220-240, 1, 50
1,200 x 235 x 690	1,600 x 235 x 690	1,600 x 235 x 690	1,600 x 235 x 690
28.0	36.5	36.5	36.5
20.0 / 18.0 / 16.0	28.0 / 24.0 / 20.0	30.0 / 25.0 / 20.0	30.0 / 25.0 / 20.0
BLDC	BLDC	BLDC	BLDC
47 / 45 / 42	44 / 41 / 38	46 / 42 / 38	46 / 42 / 38

CEILING SUSPENDED

# SPECIFICATIONS

## CEILING SUSPENDED UNIT - HIGH EFFICIENCY



### TROPICAL COOL

Combination	Outdoor unit		Unit	AVUQ18GM1T1	AVUQ24GM1T1
	Indoor unit			AVNQ18GM1T1	AVNQ24GM1T1
Cooling Capacity <sup>1)</sup>	Min. - Rated - Max.		kW	2.1-5.27-5.86	2.81-7.03-7.91
			Btu/h	7,200-18,000-20,000	9,600-24,000-27,000
Cooling Capacity <sup>2)</sup>	Min. - Rated - Max.		kW	4.37	6.04
			Btu/h	14,900	20,610
Power Input	Cooling <sup>1)</sup>	Rated	kW	1.55	2.06
	Cooling <sup>2)</sup>	Rated	kW	1.73	2.38
EER / COP			W/W	3.40	3.41
<b>Outdoor</b>			<b>Unit</b>	<b>AVUQ18GM1T1</b>	<b>AVUQ24GM1T1</b>
Power Supply			V, ∅, Hz	220-240, 1, 50	220-240, 1, 50
Power Supply Cable (included Earth)			No. × mm <sup>2</sup>	3C × 2.5	3C × 2.5
Dimensions	Net	W × H × D	mm	770 × 545 × 288	870 × 650 × 330
Weight	Net		kg	34.3	43.3
Compressor	Type		-	Twin Rotary	Twin Rotary
Refrigerant	Type		-	R410A	R410A
Fan	Air Flow Rate	Rated	m <sup>3</sup> /min × No.	28 × 1	50 × 1
		Rated	ft <sup>3</sup> /min × No.	989 × 1	1,766 × 1
Fan Motor	Type		-	BLDC	BLDC
Sound Pressure Level	Cooling	Rated	dB(A)	49	50
Piping Connections	Liquid	Outer Dia.	mm (inch)	∅ 6.35 (1/4)	∅ 9.52 (3/8)
	Gas	Outer Dia.	mm (inch)	∅ 12.7 (1/2)	∅ 15.88 (5/8)
Piping Length		Rated	m	5	5
		Min./Max.	m	5/30	5/50
Maximum Height Difference (ODU - IDU)	Max.		m	15	30
<b>Indoor</b>			<b>Unit</b>	<b>AVNQ18GM1T1</b>	<b>AVNQ24GM1T1</b>
Power Supply			V, ∅, Hz	220-240, 1, 50	220-240, 1, 50
Dimensions	Net	W × H × D	mm	1,200 × 235 × 690	1,200 × 235 × 690
Weight	Net		kg	27.3	28.0
Air Flow Rate		H / M / L	m <sup>3</sup> /min	13.0 / 12.0 / 11.0	16.5 / 15.0 / 14.0
Fan Motor	Type		-	BLDC	BLDC
Sound Pressure Level		H / M / L	dB(A)	40 / 38 / 37	44 / 43 / 41

Notes

- Cooling<sup>1)</sup> : Indoor Temperature 27°C (80.6°F) DB / 19°C (66.2°F) WB, Outdoor Temperature 35°C (95°F) DB / 24°C (75.2°F) WB  
 - Cooling<sup>2)</sup> : Indoor Temperature 29°C (84.2°F) DB / 19°C (66.2°F) WB, Outdoor Temperature 46°C (114.8°F) DB / 24°C (75.2°F) WB

### TROPICAL COOL

AVUQ30GM1T1	AVUQ36GM2T1	AVUQ48GM2T1	AVUQ54GM2T1
AVNQ30GM1T1	AVNQ36GM2T1	AVNQ48GM2T1	AVNQ54GM2T1
3.36-8.2-10.26	4.46-9.49-11.13	5.39-13.48-15.53	6.33-15.82-16.7
11,480-28,000-35,000	15,230-32,400-38,000	18,400-46,000-53,000	21,600-54,000-57,000
7.05	8.16	10.51	12.66
24,080	27,860	35,880	43,200
2.41	2.79	3.96	5.39
2.85	3.23	4.10	5.00
3.40	3.40	3.40	2.94
AVUQ30GM1T1	AVUQ36GM2T1	AVUQ48GM2T1	AVUQ54GM2T1
220-240, 1, 50	220-240, 1, 50	220-240, 1, 50	220-240, 1, 50
3C × 2.5	3C × 2.5	3C × 6.0	3C × 6.0
950 × 834 × 330	950 × 834 × 330	950 × 1,380 × 330	950 × 1,380 × 330
59.1	59.1	89.5	89.5
Twin Rotary	Twin Rotary	LG Inverter Scroll	LG Inverter Scroll
R410A	R410A	R410A	R410A
60 × 1	60 × 1	60 × 2	60 × 2
2,119 × 1	2,119 × 1	2,119 × 2	2,119 × 2
BLDC	BLDC	BLDC	BLDC
51	51	55	55
∅ 9.52(3/8)	∅ 9.52(3/8)	∅ 9.52 (3/8)	∅ 9.52 (3/8)
∅ 15.88 (5/8)	∅ 15.88 (5/8)	∅ 19.05 (3/4)	∅ 19.05 (3/4)
5	5	5	5
5/50	5/50	5/75	5/75
30	30	30	30
AVNQ30GM1T1	AVNQ36GM2T1	AVNQ48GM2T1	AVNQ54GM2T1
220-240, 1, 50	220-240, 1, 50	220-240, 1, 50	220-240, 1, 50
1,200 × 235 × 690	1,600 × 235 × 690	1,600 × 235 × 690	1,600 × 235 × 690
28.0	36.5	36.5	36.5
20.0 / 18.0 / 16.0	28.0 / 24.0 / 20.0	30.0 / 25.0 / 20.0	30.0 / 25.0 / 20.0
BLDC	BLDC	BLDC	BLDC
47 / 45 / 42	44 / 41 / 38	46 / 42 / 38	46 / 42 / 38

CEILING SUSPENDED



# SPECIFICATIONS

## CEILING SUSPENDED UNIT - STANDARD



AUUW36GS1



AUUW48LS1  
AUUW54LS1

**HEAT**

Combination	Outdoor unit		Unit	AUUW36GS1
	Indoor unit			AVNW36GM1S1
Power Supply	Ø, Voltage, Hz		-	1,220-240,50
Capacity	Cooling*	Rated	kW	4.00 - 8.49 - 10.30
		Rated	Btu/h	13,600 - 29,000 - 35,000
	Heating	Min. - Rated - Max.	kW	4.30 - 10.00 - 11.70
		Min. - Rated - Max.	Btu/h	14,700 - 34,000 - 39,900
Power Input	Cooling*	Rated	W	2,710
	Heating*	Rated	W	3,050
EER / COP			W/W	3.24 / 3.28
<b>Outdoor</b>			<b>Unit</b>	<b>AUUW36GS1</b>
Power Supply			V, Ø, Hz	220-240, 1, 50
Power Supply Cable (included Earth)			No. x mm <sup>2</sup>	3C x 2.5 (12)
Casing Color			-	Warm Gray
Dimensions	Net	W x H x D	mm	950 x 834 x 330
Net Weight			kg	58.0 (127.9)
Compressor	Type			Twin Rotary
Refrigerant	Type			R410A
Fan	Air Flow Rate	Rated	m <sup>3</sup> /min x No.	58 x 1
Fan Motor	Type			BLDC
Sound Pressure Level	Cooling	Rated	dB(A)	56
	Heating	Rated	dB(A)	58
Piping Connections	Liquid	Outer Dia.	mm (inch)	Ø 9.52 (3/8)
	Gas	Outer Dia.	mm (inch)	Ø 15.88 (5/8)
Piping Length	Max.		m	40 (131.2)
Maximum Height Difference (ODU - IDU)	Max.		m	30 (98.4)
<b>Indoor</b>			<b>Unit</b>	<b>AVNW36GM1S1</b>
Power Supply			V, Ø, Hz	220-240, 1, 50/60
Dimensions	Body	W x H x D	mm	1,200 x 235 x 690
Net Weight			kg (lbs)	28.0 (61.7)
Fan	Air Flow Rate	H / M / L	m <sup>3</sup> /min	20.0 / 18.0 / 16.0
Fan Motor	Type			BLDC
External static pressure	High Mode_Factory Set		-	58.8 (6)
Sound Pressure Level	Cooling	Rated	dB(A)	47 / 45 / 42
	Heating	Rated	dB(A)	47 / 45 / 42

Notes

- Cooling<sup>1)</sup> : Indoor Temperature 27°C (80.6°F) DB / 19°C (66.2°F) WB, Outdoor Temperature 35°C (95°F) DB / 24°C (75.2°F) WB
- Cooling<sup>2)</sup> : Indoor Temperature 29°C (84.2°F) DB / 19°C (66.2°F) WB, Outdoor Temperature 46°C (114.8°F) DB / 24°C (75.2°F) WB
- Heating Temperature : Indoor 20°C (68°F) DB / 15°C (59°F) WB, Outdoor 7°C (44.6°F) DB / 6°C (42.8°F) WB

**HEAT**

AUUW48LS1		AUUW54LS1
AVNW48LM2S1		AVNW60LM2S1
3,380-415,50		3,380-415,50
5.60 - 13.78 - 14.70		6.00 - 15.20 - 16.70
19,100 - 47,000 - 50,000		20,500 - 52,000 - 57,000
6.10 - 15.30 - 16.50		6.80 - 17.00 - 18.20
20,800 - 52,210 - 56,300		23,200 - 58,000 - 62,100
4,250		5,010
4,490		5,150
3.24 / 3.41		3.03 / 3.30
<b>AUUW48LS1</b>		<b>AUUW54LS1</b>
220-240, 1, 50		220-240, 1, 50
3C x 2.5 (12)		3C x 2.5 (12)
Warm Gray		Warm Gray
870 x 650 x 330		870 x 650 x 330
44.8 (98.8)		44.8 (98.8)
Twin Rotary		Twin Rotary
R410A		R410A
58 x 2		58 x 2
BLDC		BLDC
55		55
57		57
Ø 9.52 (3/8)		Ø 9.52 (3/8)
Ø 19.05 (3/4)		Ø 19.05 (3/4)
50 (164.0)		50 (164.0)
30 (98.4)		30 (98.4)
<b>AVNW48LM2S1</b>		<b>AVNW60LM2S1</b>
220-240, 1, 50/60		220-240, 1, 50/60
1,600 x 235 x 690		1,600 x 235 x 690
35.0 (77.2)		35.0 (77.2)
30.0 / 25.0 / 20.0		30.0 / 25.0 / 20.0
BLDC		BLDC
58.8 (6)		58.8 (6)
50 / 46 / 42		50 / 46 / 42
50 / 46 / 42		50 / 46 / 42

CEILING SUSPENDED

# FLOOR STANDING UNIT



## POWERFUL AIRFLOW

The new LG floor standing air conditioner is efficient for using in large areas due to its powerful cooling and heating operation. The powerful air speed and volume means the air flow can reach up to 20m away from the air conditioner.



## EXCELLENT COOLING PERFORMANCE

Power cooling function provides the optimal airflow angle, and it guarantees a faster and higher cooling performance.

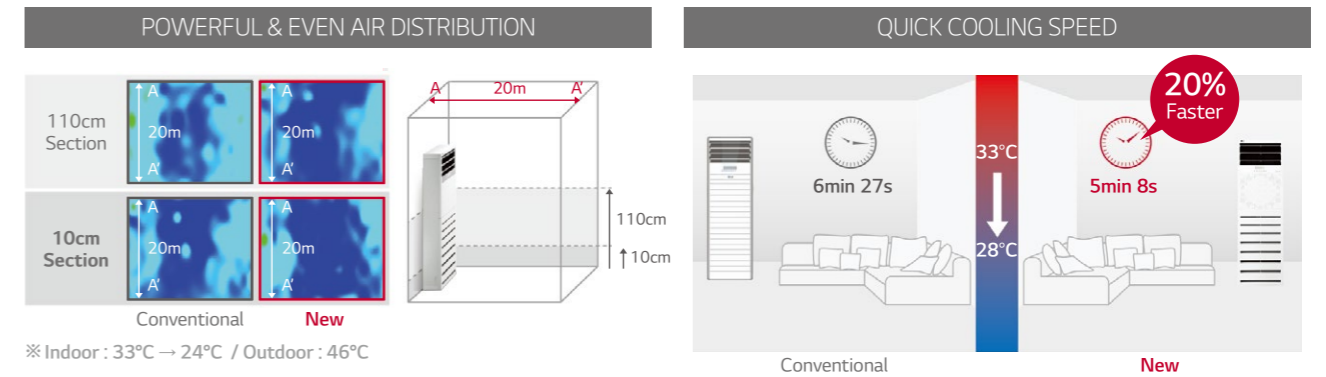

## STYLISH DESIGN

The new LG floor standing air conditioner is ideal for modern interiors in your office or restaurant.



# SPECIFICATIONS

## FLOOR STANDING UNIT - HIGH EFFICIENCY



### TROPICAL HEAT

Combination	Outdoor unit		Unit	APUW36GT3S1	APUW50GT3EO	APUW50LT3EO	APNW100LFTO
	Indoor unit			APNW36GT3S1	APNW50GT3EO	APNW50LT3EO	APUW100LFTO
Capacity	Cooling <sup>1)</sup>	Min. - Rated - Max	kW	3.8 - 10.0 - 10.6	5.6 - 13.51 - 15.5	5.6 - 13.51 - 15.5	28.43
		Min. - Rated - Max	Btu/h	13,000 - 34,100 - 36,200	19,100 - 46,100 - 52,900	19,100 - 46,100 - 52,900	97,000
	Cooling <sup>2)</sup>	Rated	kW	8.10	11.72	11.72	22.57
		Rated	Btu/h	27,600	40,000	40,000	77,000
Power Input	Heating	Min. - Rated - Max	kW	4.1 - 10.8 - 11.5	6.2 - 14.65 - 16.7	6.2 - 14.65 - 16.7	28.72
		Min. - Rated - Max	Btu/h	14,000 - 36,800 - 39,200	21,200 - 50,000 - 57,000	21,200 - 50,000 - 57,000	98,000
	Cooling <sup>1)</sup>	Rated	kW	3.32	3.88	3.88	11.2
		Rated	kW	3.27	4.65	4.65	10.8
EER / COP	Cooling <sup>1)</sup> / Heating	Rated	kW	3.17	4.15	4.15	10.5
		W/W		3.01/3.41	3.48/3.53	3.48/3.53	2.54/2.74
<b>Outdoor</b>			<b>Unit</b>	<b>APUW36GT3S1</b>	<b>APUW50GT3EO</b>	<b>APUW50LT3EO</b>	<b>APUW100LFTO</b>
Power Supply			V, Ø, Hz	220-240, 1, 50	220-240, 1, 50	380-415, 3, 50	380-415, 3, 50
Power Supply Cable (included Earth)			No. x mm <sup>2</sup>	3C x 2.5 (12)	3C x 6.0	5C x 2.5	5C x 6.0
Casing Color			-	Warm Gray	Warm Gray	Warm Gray	-
Dimensions	Net	W x H x D	mm	950 x 834 x 330	950 x 1,380 x 330	950 x 1,380 x 330	1,090 x 1,625 x 380
Net Weight	Body		kg (lbs)	58.0 (127.9)	93.5 (206.1)	93.5 (206.1)	153 (337.3)
Compressor	Type		-	Twin Rotary	Twin Rotary	Twin Rotary	BLDC INV Scroll
Refrigerant	Type		-	R410A	R410A	R410A	R410A
Fan Motor	Type		-	BLDC	BLDC	BLDC	BLDC
Sound Pressure Level	Cooling	Rated	dB(A)	56	62	62	60
Piping Connections	Liquid	Outer Dia.	mm (inch)	Ø 9.52 (3/8)	Ø9.52 (3/8)	Ø9.52 (3/8)	Ø9.52 (3/8)
	Gas	Outer Dia.	mm (inch)	Ø 15.88 (5/8)	Ø19.05 (3/4)	Ø19.05 (3/4)	Ø 22.2 (7/8)
Piping Length		Min/Max	m	40 (131.2)	5 (16.4) / 30 (98.4)	5 (16.4) / 30 (98.4)	5(16.4) / 50(164.04)
Maximum Height Difference (ODU - IDU)		Max.	m	30 (98.4)	20 (65.6)	20 (65.6)	30 (98.43)
<b>Indoor</b>			<b>Unit</b>	<b>APNW36GT3S1</b>	<b>APNW50GT3EO</b>	<b>APNW50LT3EO</b>	<b>APNW100LFTO</b>
Power Supply			V, Ø, Hz	220-240, 1, 50	220-240, 1, 50	220-240, 1, 50	380-415, 3, 50
Dimensions	Body	W x H x D	mm	590 x 1,840 x 440	590 x 1,840 x 440	590 x 1,840 x 440	1,050 x 1,880 x 495
		W x H x D	inch	23-7/32 x 72-7/16 x 17-5/16	23-7/32 x 72-7/16 x 17-5/16	23-7/32 x 72-7/16 x 17-5/16	41-1/4 x 74-7/16 x 19-1/8
Net Weight	Body		kg (lbs)	47 (103.6)	47 (103.6)	47 (103.6)	113 (249)
Fan	Air Flow Rate	SH / H / M / L	m <sup>3</sup> /min	37 / 33 / 30 / 26	38 / 33 / 28 / 24	38 / 33 / 28 / 24	68 / 61 / - / 50
Fan Motor	Type		-	External BLDC	External BLDC	BLDC	BLDC
Sound Pressure Level	Cooling	SH / H / M / L	dB(A)	55 / 52 / 49 / 47	55 / 52 / 49 / 47	55 / 52 / 49 / 47	60 / 57 / - / 53

### TROPICAL COOL

APUQ50LT3EO		APUQ100LFTO	
APNQ50LT3EO		APNQ100LFTO	
13.51		28.43	
46,100		97,000	
11.72		22.57	
40,000		77,000	
-		-	
-		-	
3.88		11.20	
4.65		10.80	
-		-	
3.48/-		2.54/-	
<b>APUQ50LT3EO</b>		<b>APUQ100LFTO</b>	
380-415, 3, 50		380-415, 3, 50	
5C X 2.5		5C X 6.0	
Warm Gray		Warm Gray	
950 x 1,380 x 330		1,090 x 1,625 x 380	
89.0 (196.2)		153 (337.3)	
Twin Rotary		BLDC INV Scroll	
R410A		R410A	
BLDC		BLDC	
62		60	
Ø9.52 (3/8)		Ø9.52 (3/8)	
Ø19.05 (3/4)		Ø 22.2 (7/8)	
5 (16.4) / 30 (98.4)		5 (16.4) / 50 (164.04)	
20 (65.6)		30 (98.43)	
<b>APNQ50LT3EO</b>		<b>APNQ100LFTO</b>	
220-240, 1, 50		380-415, 3, 50	
590 x 1,840 x 440		1,050 x 1,880 x 495	
23-7/32 x 72-7/16 x 17-5/16		41-1/4 x 74-7/16 x 19-1/8	
47 (103.6)		113 (249)	
37 / 33 / 28 / 24		68 / 61 / - / 50	
External BLDC		BLDC	
54 / 51 / 49 / 47		60 / 57 / - / 53	

Notes

- Cooling<sup>1)</sup>: Indoor Temperature 27°C (80.6°F) DB / 19°C (66.2°F) WB, Outdoor Temperature 35°C (95°F) DB / 24°C (75.2°F) WB  
 - Heating Temperature: Indoor 20°C (68°F) DB / 15°C (59°F) WB, Outdoor 7°C (44.6°F) DB / 6°C (42.8°F) WB

# SPECIFICATIONS

## FLOOR STANDING UNIT - STANDARD



### TROPICAL HEAT

Combination	Outdoor unit		Unit	APUW24GS1S1	APUW36GT3S1	APUW48GT3S1	APUW48LT3S1	
	Indoor unit			APNW24GS1S1	APNW36GT3S1	APNW48GT3S1	APNW48LT3S1	
Capacity	Cooling <sup>1)</sup>	Min. - Rated - Max.	kW	2.8 - 7.0 - 7.7	3.8 - 10.0 - 10.6	5.6 - 14.1 - 15.5	5.6 - 14.1 - 15.5	
		Min. - Rated - Max.	Btu/h	9,600 - 23,900 - 26,300	13,000 - 34,100 - 36,200	19,100 - 48,100 - 52,900	19,100 - 48,100 - 52,900	
	Cooling <sup>2)</sup>	Rated	kW	5.80	8.10	12.20	12.20	
		Rated	Btu/h	19,800	27,600	41,600	41,600	
Heating	Min. - Rated - Max.	kW	3.0 - 7.6 - 8.5	4.1 - 10.8 - 11.5	6.2 - 15.5 - 16.5	6.2 - 15.5 - 16.5		
	Min. - Rated - Max.	Btu/h	10,200 - 25,900 - 29,000	14,000 - 36,800 - 39,200	21,200 - 52,900 - 56,300	21,200 - 52,900 - 56,300		
Power Input	Cooling <sup>1)</sup>	Rated	kW	2.33	3.32	4.65	4.65	
	Cooling <sup>2)</sup>	Rated	kW	2.75	3.27	5.10	5.10	
	Heating <sup>1)</sup>	Rated	kW	2.53	3.17	4.55	4.55	
EER / COP	Cooling <sup>1)</sup> / Heating		W/W	3.01/3.01	3.01/3.41	3.03/3.41	3.03/3.41	
<b>Outdoor</b>			<b>Unit</b>	<b>APUW24GS1S1</b>	<b>APUW36GT3S1</b>	<b>APUW48GT3S1</b>	<b>APUW48LT3S1</b>	
Power Supply			V, ∅, Hz	220-240, 1, 50	220-240, 1, 50	220-240, 1, 50	220-240, 1, 50	
Power Supply Cable (included Earth)			No. x mm <sup>2</sup>	3C x 2.5 (12)	3C x 2.5 (12)	3C x 6.0 (10)	5C x 2.5(12)	
Casing Color			-	Warm Gray	Warm Gray	Warm Gray	Warm Gray	
Dimensions	Net	W x H x D	mm	870 x 650 x 330	950 x 834 x 330	950 x 1,380 x 330	950 x 1,380 x 330	
Net Weight	Body		kg	44.8 (98.8)	58.0 (127.9)	90.0 (198.4)	90.0 (198.4)	
Compressor	Type		-	Twin Rotary	Twin Rotary	Twin Rotary	Twin Rotary	
Refrigerant	Type		-	R410A	R410A	R410A	R410A	
Fan Motor	Type		-	BLDC	BLDC	BLDC	BLDC	
Sound Pressure Level	Cooling	Rated	dB(A)	55	56	55	55	
Piping Connections	Liquid	Outer Dia.	mm (inch)	∅ 9.52 (3/8)	∅ 9.52 (3/8)	∅ 9.52 (3/8)	∅ 9.52 (3/8)	
	Gas	Outer Dia.	mm (inch)	∅ 15.88 (5/8)	∅ 15.88 (5/8)	∅ 19.05 (3/4)	∅ 19.05 (3/4)	
Piping Length	Max.	m		30 (98.4)	40 (131.2)	50 (164.0)	50 (164.0)	
Maximum Height Difference (ODU - IDU)	Max.	m		30 (98.4)	30 (98.4)	30 (98.4)	30 (98.4)	
<b>Indoor</b>			<b>Unit</b>	<b>APNW24GS1S1</b>	<b>APNW36GT3S1</b>	<b>APNW48GT3S1</b>	<b>APNW48LT3S1</b>	
Power Supply			V, ∅, Hz	220-240, 1, 50	220-240, 1, 50	220-240, 1, 50	220-240, 1, 50	
Dimensions			Body	W x H x D	mm	530 x 1,800 x 295	590 x 1,840 x 440	590 x 1,840 x 440
				W x H x D	inch	20-7/8 x 70-7/8 x 11-5/8	23-7/32 x 72-7/16 x 18-1/8	23-7/32 x 72-7/16 x 18-1/8
Net Weight			kg (lbs)	26 (57.3)	47 (103.6)	47 (103.6)	47 (103.6)	
Fan	Air Flow Rate	SH / H / M / L	m <sup>3</sup> /min	17.5 / 16.5 / - / 15.0	37.0 / 33.0 / 30.0 / 26.0	38.0 / 33.0 / 28.0 / 24.0	38.0 / 33.0 / 28.0 / 24.0	
Fan Motor	Type		-	BLDC	BLDC	BLDC	BLDC	
Sound Pressure Level	Cooling	SH / H / M / L	dB(A)	47 / 45 / - / 43	55 / 52 / 49 / 47	55 / 52 / 49 / 47	55 / 52 / 49 / 47	

### COOL

APUQ18GS1K1		APUQ30GS1K1	
APNQ18GS1K1		APNQ30GS1K1	
1.58 - 5.28 - 5.77		2.2 - 7.33 - 7.83	
5,400 - 18,000 - 19,700		7,500 - 25,000 - 26,700	
-		-	
-		-	
-		-	
1.75		2.43	
-		-	
-		-	
3.02/-		3.02/-	
APUQ18GS1K1		APUQ30GS1K1	
220-240, 1, 50		220-240, 1, 50	
3C x 2.5		3C x 4.0	
Warm Gray		Warm Gray	
770 x 545 x 288		870 x 650 x 330	
33.4 (73.6)		42.0 (92.6)	
Twin Rotary		Twin Rotary	
R410A		R410A	
BLDC		BLDC	
47		53	
∅ 6.35 (1/4)		∅ 9.52 (3/8)	
∅ 12.7 (1/2)		∅ 15.88 (5/8)	
30 (98.4)		50 (164.0)	
20 (65.6)		30 (98.4)	
APNQ18GS1K1		APNQ30GS1K1	
220-240, 1, 50		220-240, 1, 50	
-		-	
530 x 1,800 x 295		530 x 1,800 x 295	
-		-	
25.3 (55.8)		25.3 (55.8)	
15.0 / 12.0 / - / 10.0		15.0 / 12.0 / - / 10.0	
BLDC		BLDC	
45 / 43 / - / 41		45 / 43 / - / 41	

Notes

- Cooling<sup>1)</sup> : Indoor Temperature 27°C (80.6°F) DB / 19°C (66.2°F) WB, Outdoor Temperature 35°C (95°F) DB / 24°C (75.2°F) WB
- Cooling<sup>2)</sup> : Indoor Temperature 29°C (84.2°F) DB / 19°C (66.2°F) WB, Outdoor Temperature 46°C (114.8°F) DB / 24°C (75.2°F) WB
- Heating Temperature : Indoor 20°C (68°F) DB / 15°C (59°F) WB, Outdoor 7°C (44.6°F) DB / 6°C (42.8°F) WB

# SINGLE PACKAGE



## ADVANCED KEY COMPONENTS FOR HIGH ENERGY EFFICIENCY

High energy efficiency with LG's cutting-edge core components and Inverter leading technology.

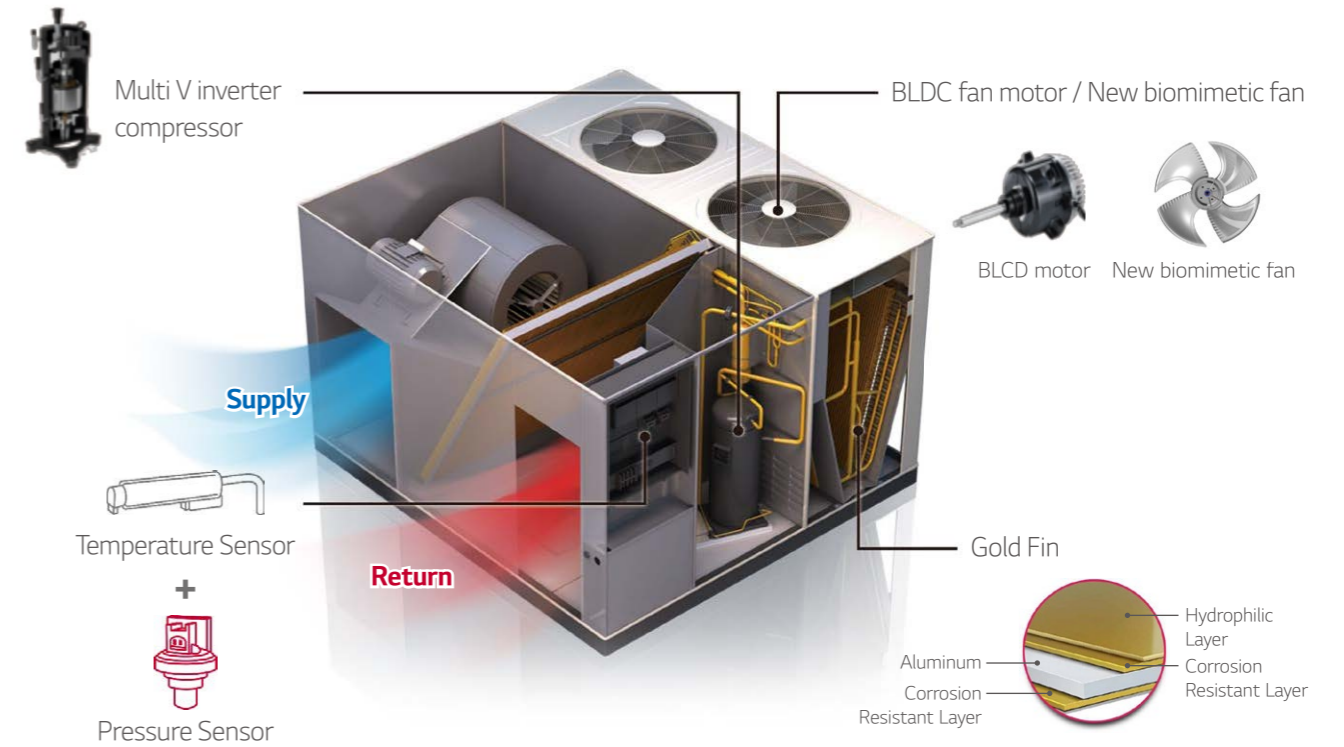

## COMPACT SIZE

Easy transportation and less space for installation.

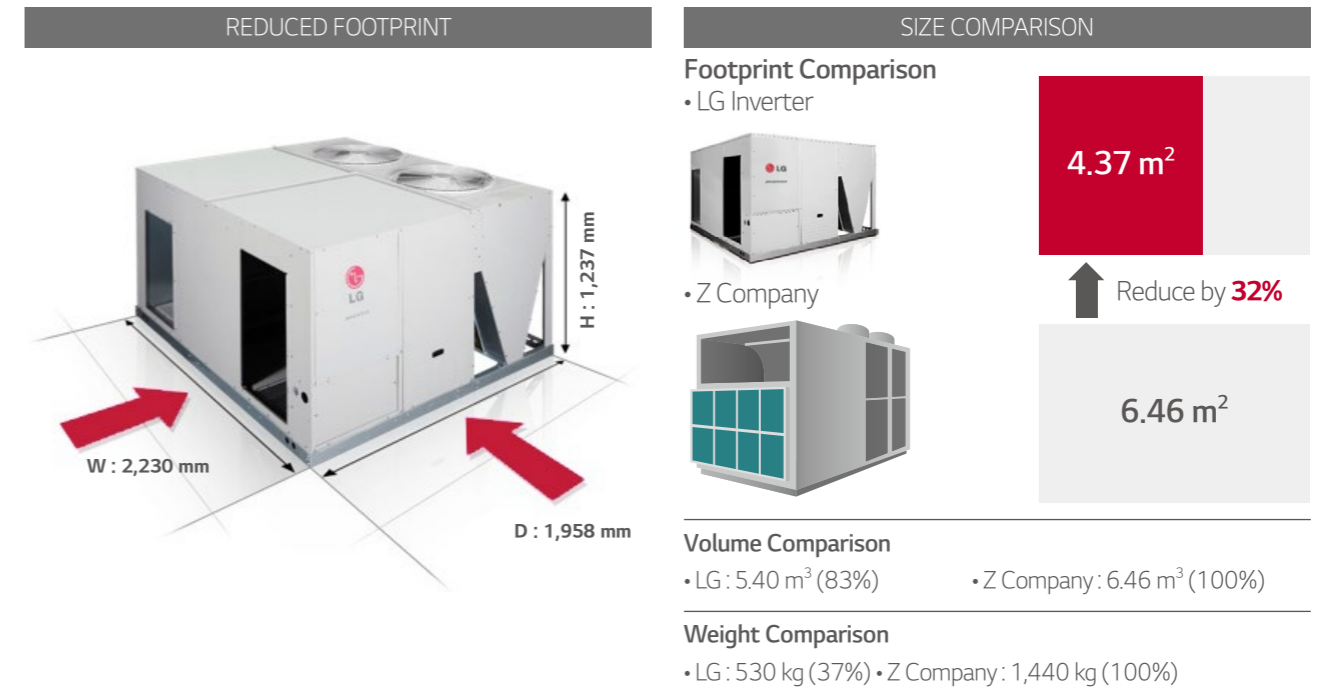

# SINGLE PACKAGE

## ANNUAL ENERGY SAVINGS

Target low pressure will be adjusted according to cooling load. LG provides energy saving by preventing On / Off operation with inverter technology.

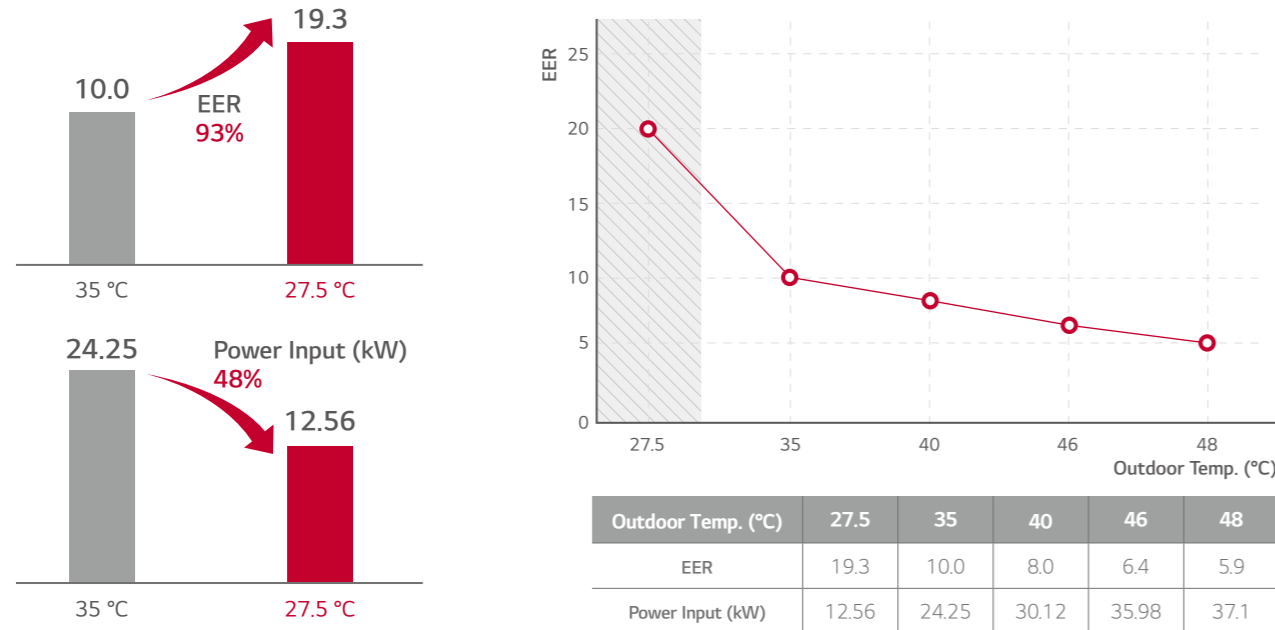

※ Model : LG AK-Q300DC01

## BENEFITS FOR CUSTOMER

Daily Energy Saving ratio compared to constant model (April 40%, Aug 20%)  
 → KSA, Madinah, real temperature based, LG DUAL Inverter elec. consumption simulation

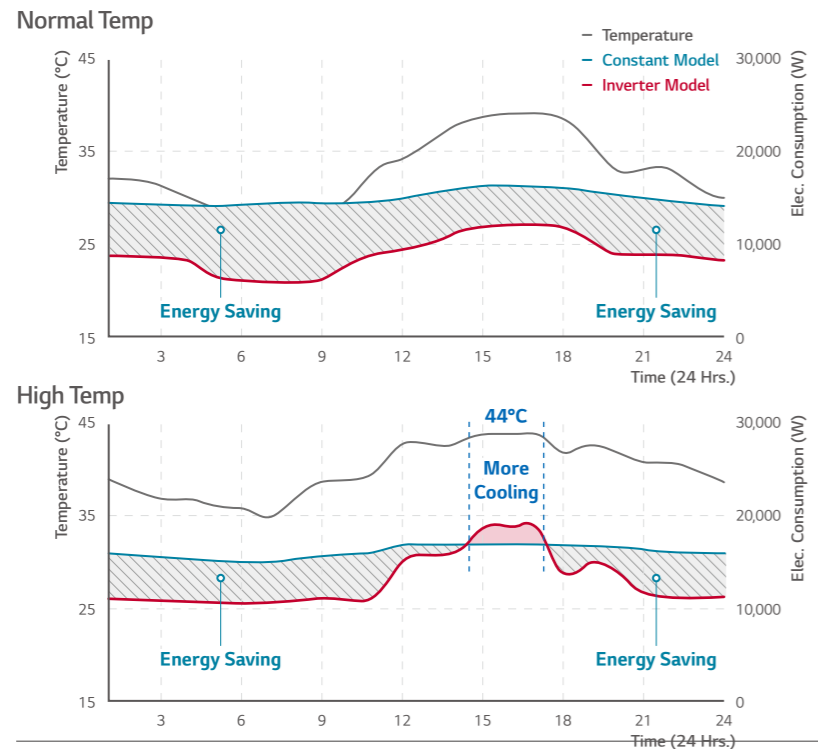

### Energy Efficiency

Time	Apr		Aug	
	Outside Temp (°C)	Elec. Consumption (W)	Outside Temp (°C)	Elec. Consumption (W)
3:00 AM	31	1429	37	1563
6:00 AM	28	1412	36	1540
9:00 AM	28	1412	39	1607
12:00 PM	34	1496	43	1699
3:00 PM	39	1607	44	1723
6:00 PM	39	1607	42	1674
9:00 PM	33	1473	41	1652
12:00 AM	30	1406	39	1607

※ Data: Weather Underground, Inc.

## RELIABLE PERFORMANCE

Field tests in extreme (tropical) conditions are being conducted without failure over a year.

**Installation Site 1**

- Location : Riyadh, Saudi Arabia
- Application : Factory (warehouse)
- Operation period : 23rd April 2012 -
- Capacity : 12.5RT
- Power : 3phase 380V 60Hz

**Installation Site 2**

- Location : Dubai, UAE
- Application : Mosque (roof)
- Operation period : 8th April 2012 -
- Capacity : 12.5RT
- Power : 3phase 400V 50Hz

※ Structure / Performance / Noise / Installation / Dew formation.....

## AUTOMATIC TEST RUN

Easy and fast automatic test run saves time during the final stage of installation.

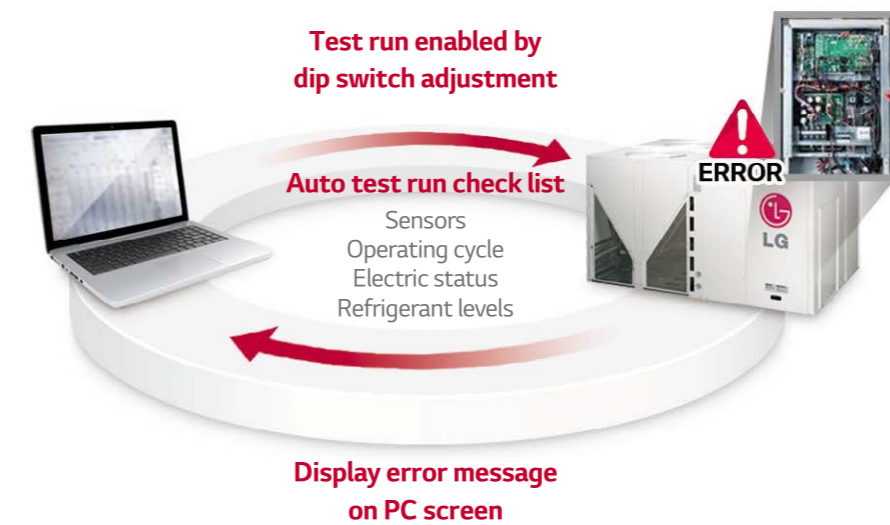

# SINGLE PACKAGE

## INITIAL COST SAVING

Reduce customer's initial cost through a heat pump system.

### CONVENTIONAL (COOLING ONLY UNIT + ELECTRIC HEATER)

- Because of a electric heater, it requires to increase the electrical capacity of the entire building.

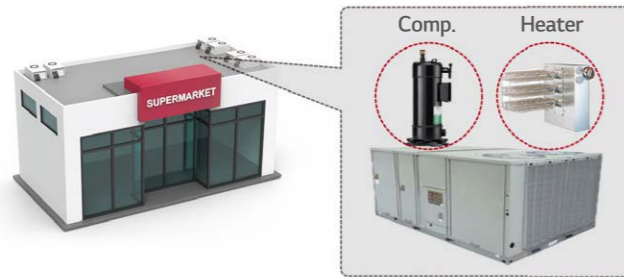

\* Only be adapted for Heat Pump model.

### LG SINGLE PACKAGE (HEAT PUMP)

- Reduce the electrical capacity of the entire building. Customers can save the cost.

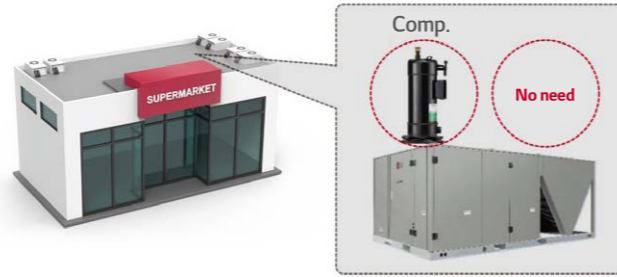

\* T com: TH\*300 - MCA : 102A MFA : 110A  
\* LG: AK-W300DC00 - MCA : 69A MFA : 80A

## LG PLUG FAN AND INVERTER MOTOR

Be able to operate high static pressure condition without extra cost.

### CONVENTIONAL (AC MOTOR)

- To cover whole space, it needs to change high static drive and motor with extra cost.
- 7.5 HP AC motor

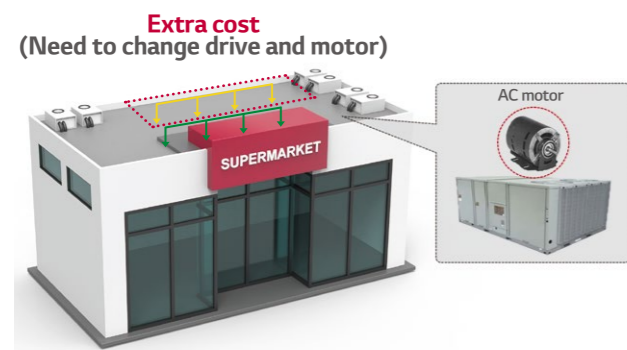

\* T company : TH\*300

External Static Pressure (Inches of Water, in.Aq)	
0.1 - 0.6	0.7 - 2.0
Standard	<b>Extra cost</b>

\* Only be adapted for Heat Pump model.

### LG SINGLE PACKAGE (INVERTER MOTOR)

- LG single package can cover whole range without extra cost.
- 10 HP Inverter motor (LG's standard feature)

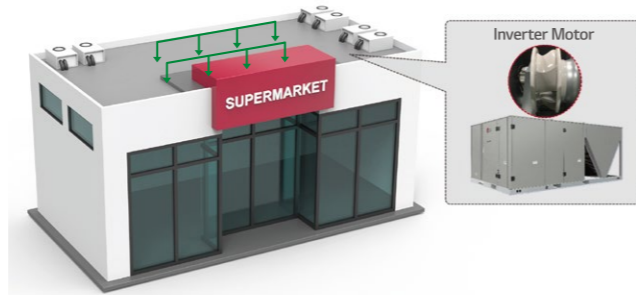

\* LG single package : AK-W300DC00

External Static Pressure (Inches of Water, in.Aq)	
0.1 - 0.6	0.7 - 2.0
<b>Standard Extra cost</b>	

## HIGH EFFICIENCY INVERTER COMPRESSOR, ECONOMIZER

Save operation cost through Inverter compressor, Dual SLC function and Economizer.

### INVERTER COMPRESSORS & DUAL(TEMP.+HUMIDITY) SENSING

- Linear control with high efficiency inverter compressor
- Dual(Temperature + Humid) sensing function

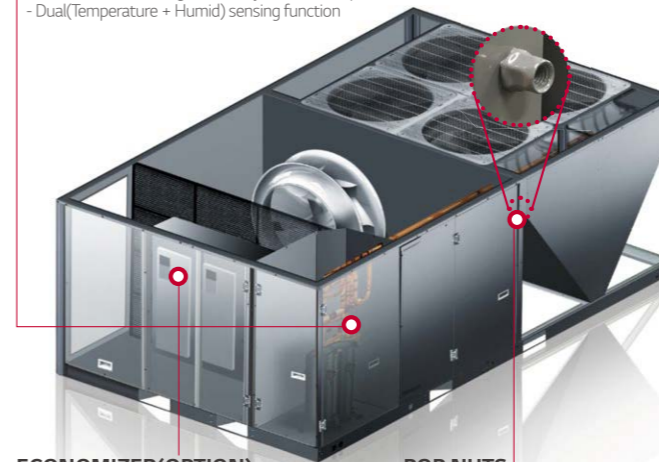

### ECONOMIZER(OPTION)

- Energy consumption can be saved by economizer in case OA enthalpy is lower than IA enthalpy

### POP NUTS

- Pop nuts allow parts to be assembled strongly.
- Pop nuts improve wear reliability.

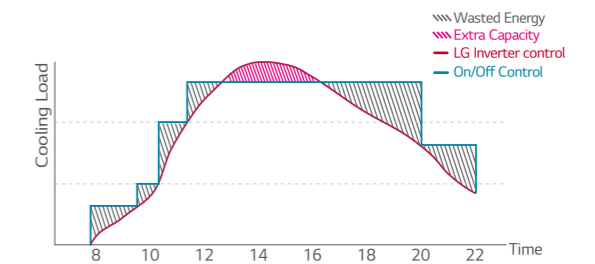

**IEER 48% ↑**

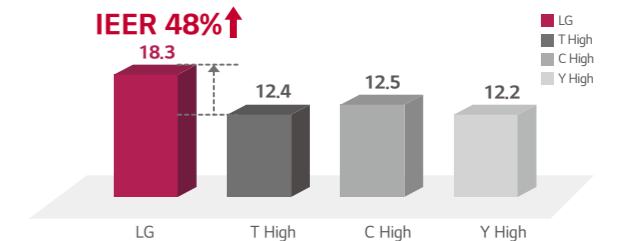

\* IEER: Integrated Energy Efficiency Ratio \* LG : 25RT Model / Others : High efficiency 25RT model

\* Only be adapted for Heat Pump model.

## BELTLESS DIRECT DRIVEN FAN & MOTOR

Save maintenance cost because of a fan and a motor that are driven beltless.

### CONVENTIONAL (FAN + PULLEY + BELT + AC MOTOR)

- Need to adjust pulleys & belts and grease periodically



Additional parts

Reduced maintenance points

Maintenance cost 26% ↓

### LG SINGLE PACKAGE (PLUG FAN + INVERTER MOTOR)

- No need to adjust pulleys & belts and grease periodically



No additional parts

\* Maintenance cost details  
 - Labor cost(General) : 2 people 2.5 hour per month, \$20 x 2.5Hr x 2P x 4EA = Total \$400  
 - Belt check : 2 people 30 minutes per month, \$20 x 0.5Hr x 2P x 4EA = Total \$80 (LG no required)  
 - Belt replacement : Every 4 months, 2 people 1 hour, (\$20 x 1Hr x 2P x 4EA) / 4 Month = Total \$40 (LG no required)  
 - Belt price : Every 4 months, 1 Belt, (\$20 x 4EA) / 4 Month = Total \$20 (LG no required)

## LIFESPAN EXTENSION

Extend with Filters and Pop nuts.

### FILTERS (PRE-FILTERS)

- Pre-filters are standard features
- Pre-filters allow customers to use 2" filters longer.

※ Pre filters can be cleaned easily by water.  
 ※ Pre filters and 2" filters are sliding removal structures.

\* Only be adapted for Heat Pump model.



### BURRING / POP NUTS

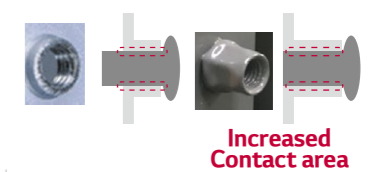

# SPECIFICATIONS

## SINGLE PACKAGE - HIGH EFFICIENCY



### TROPICAL HEAT

Nominal Capacity		RT	20	25
Model Name		-	AK-W240LC00	AK-W300LC00
Cooling Capacity	Net Capacity	kW	70.0	81.0
		kcal/h	60,480	69,600
		Btu/h	240,000	276,000
	Gross Capacity	kW	72.4	83.5
		kcal/h	62,250	71,800
		Btu/h	247,000	285,000
Heating Capacity	Capacity	kW	70.3	80.9
		kcal/h	60,480	69,600
		Btu/h	240,000	276,000
EER		Btu / Wh	11.3	10.6
IEER		Btu / Wh	19.0	18.3
COP		W / W	3.38	3.24
Power Input	Cooling	kW	21.3	26.0
	Heating	kW	20.8	25.0
Power Supply		V, Ø, Hz	380-415, 3, 50/60	380-415, 3, 50/60
Indoor Coil	Fin Type		LG Louver	
	Tube Size	Outer Dia.	9.52 (3/8)	
	(Row x Column x Fins per inch) x No.		(4 x 44 x 16) x 2	
	Length		2.01 (21.6)	
	Face Area		2.18 (23.47)	
Indoor Fan	Type		Plug Fan	
	Diameter		630 (25)	
	Motor Output		10	
	Air Flow Rate	Nominal	227	
		Nominal	8,000	
Drive type		BLDC Inverter		
Compressor (#1, A Cycle)	Type		HSS DC SCROLL	
	Motor Output		5,500 x 1	
	Oil Type		FVC68D	
	Oil Charge		1,500 x 1	
Compressor (#2, B Cycle)	Type		HSS DC SCROLL	
	Motor Output		5,500 x 1	
	Oil Type		FVC68D	
	Oil Charge		1,500 x 1	
Outdoor Coil	Fin Type		Wide Louver Plus	
	Tube Size	Outer Dia.	7 (9/32)	
	(Row x Column x Fins per inch) x No.		(3 x 52 x 14) x 2	
	Face Area		4.5 (48.4)	
Outdoor Fan	Type		Propeller Fan	
	Diameter		680 (26-25/32)	
	Motor Output		900 x 4	
	Air Flow Rate		105 x 4	
	Drive		BLDC Inverter	
Discharge Direction		Top		
Dehumidification rate		l/h	24.1	30.1
Drain Connection Size		-	NPT 1"	
Refrigerant	Refrigerant name		R410A	
	Precharged Amount	A-Circuit	9.0	
		B-Circuit	9.0	
	Control		Electronic Expansion Valve	
Dimensions (W x H x D)		mm	2,230 x 1,242 x 3,520	
Net Weight		kg (lbs)	87-25/32 x 48-29/32 x 138-19/32	
Sound pressure levels	Cooling		77	
	Operation Range (Outdoor Temperature)	Cooling	Min. - Max.	°C DB (°FDB)
Heating		Min. - Max.	°C WB (°FWB)	-15 - 18 (5.0 - 64.4)



### TROPICAL COOL

Nominal Capacity		RT	6.5	7.5
Model Name		-	AK-Q0788C01	AK-Q0908C01
Cooling Capacity	Net Capacity	kW	22.9	26.4
		kcal/h	19,700	22,700
		Btu/h	78,000	90,000
	Gross Capacity	kW	24.0	27.5
		kcal/h	20,700	23,700
		Btu/h	82,000	94,000
EER		Btu / Wh	12.8	11.8
Power Input		Cooling	kW	
Power Supply		V, Ø, Hz	380-415, 3, 50	380-415, 3, 50
Indoor Coil	Fin Type		LG Louver	
	Tube Size	Outer Dia.	9.52 (3/8)	
	(Row x Column x Fins per inch) x No.		(4 x 36 x 16) x 1	
	Face Area		0.84 (9.02)	
Indoor Fan	Type		Sirocco Fan	
	Diameter		331.6 (13.1)	
	Motor Output		1.5	
	Air Flow Rate	Nominal	73.6	
		Nominal	2,600	
Drive type		Belt		
Compressor (#1, A Cycle)	Type		HSS DC SCROLL	
	Motor Output		5,300 x 1	
	Oil Type		FVC68D	
	Oil Charge		1,200 x 1	
Compressor (#2, B Cycle)	Type		-	
	Motor Output		-	
	Oil Type		-	
	Oil Charge		-	
Outdoor Coil	Fin Type		Wide Louver Plus (Gold)	
	Tube Size	Outer Dia.	7 (9/32)	
	(Row x Column x Fins per inch) x No.		(3 x 44 x 14) x 1	
	Face Area		2.08 (22.38)	
Outdoor Fan	Type		Propeller Fan	
	Diameter		680 (26-25/32)	
	Motor Output		1,200 x 1	
	Air Flow Rate	m³/min x No.	105 x 1	
		ft³/min x No.	3,700 x 1	
Drive		BLDC Inverter		
Discharge Direction		Top		
Dehumidification rate		l/h	8.5	9.9
Drain Connection Size		-	Male NPT 3/4	
Refrigerant	Refrigerant name		R410A	
	Precharged Amount	A-Circuit	6.9	
		B-Circuit	-	
	Control		EEV	
Dimensions (W x H x D)		mm	2,250 x 1,106 x 1,130	
Net Weight		kg (lbs)	340 (750)	
Sound pressure levels	Cooling		70	
	Operation Range (Outdoor Temperature)	Cooling	Min. - Max.	°CDB (°FDB)



# SPECIFICATIONS

## SINGLE PACKAGE - HIGH EFFICIENCY



**TROPICAL COOL**

Nominal Capacity		RT	10	12.5	
Model Name		-	AK-Q1208C01	AK-Q1508C01	
Cooling Capacity	Net Capacity	kW	35.2	39.9	
		kcal/h	30,239	34,300	
		Btu/h	120,000	136,000	
	Gross Capacity	kW	37.5	41.5	
		Btu/h	128,000	141,800	
EER	Btu / Wh	11.6	11.6		
Power Input	Cooling	kW	10.34	11.70	
Power Supply		V, Ø, Hz	380-415, 3, 50	380-415, 3, 50	
Indoor Coil	Fin Type	-	LG Louver	LG Louver	
	Tube Size	Outer Dia.	mm (inch)	9.52 (3/8)	9.52 (3/8)
	(Row × Column × Fins per inch) × No.	-	(4 × 22 × 16) × 2	(4 × 22 × 16) × 2	
	Length	mm (inch)	1.45 (15.61)	1.45 (15.61)	
	Face Area	m <sup>2</sup> (ft <sup>2</sup> )	1.45(15.61)	1.45 (15.61)	
Indoor Fan	Type	-	Sirocco Fan	Sirocco Fan	
	Diameter	mm (inch)	380 (15)	380 (15)	
	Motor Output	Hp	3	3	
	Air Flow Rate	Nominal	m <sup>3</sup> /min	113.3	141.6
		Nominal	ft <sup>3</sup> /min	4,000	5,000
Drive type	-	Belt	Belt		
Compressor (#1, A Cycle)	Type	-	HSS DC SCROLL	HSS DC SCROLL	
	Motor Output	W × No.	5,300 × 1	5,300 × 1	
	Oil Type	-	FVC68D	FVC68D	
	Oil Charge	cc × No.	1,200 × 1	1,200 × 1	
Compressor (#2, B Cycle)	Type	-	-	-	
	Motor Output	W × No.	-	-	
	Oil Type	-	-	-	
	Oil Charge	cc × No.	-	-	
Outdoor Coil	Fin Type	-	Wide Louver Plus (Gold)	Wide Louver Plus(Gold)	
	Tube Size	Outer Dia.	mm (inch)	7 (9/32)	7 (9/32)
	(Row × Column × Fins per inch) × No.	-	(3 × 42 × 14) × 2	(3 × 42 × 14) × 2	
	Face Area	m <sup>2</sup> (ft <sup>2</sup> )	3.53 (37.99)	3.53 (37.99)	
Outdoor Fan	Type	-	Propeller Fan	Propeller Fan	
	Diameter	mm (inch)	680 (26-25/32)	680 (26-25/32)	
	Motor Output	W × No.	1,500 × 2	1,500 × 2	
	Air Flow Rate	m <sup>3</sup> /min × No.	105 × 2	105 × 2	
		ft <sup>3</sup> /min × No.	3,700 × 2	3,700 × 2	
Drive	-	BLDC Inverter	BLDC Inverter		
Discharge Direction	-	Top	Top		
Dehumidification rate	ℓ/h	13.8	15.6		
Drain Connection Size	-	Male NPT 1	Male NPT 1		
Refrigerant	Refrigerant name	-	R410A	R410A	
	Precharged Amount	A-Circuit	kg	13.0	13.0
		B-Circuit	kg	-	-
	Control	-	Electronic Expansion Valve	Electronic Expansion Valve	
Dimensions (W × H × D)	mm		2,230 × 1,237 × 1,958	2,230 × 1,237 × 1,958	
	inch		87-25/32×48-11/16×77-3/32	87-25/32×48-11/16×77-3/32	
Net Weight	kg (lbs)		530 (1,168)	530 (1,168)	
Sound pressure levels	Cooling	dB (A)	75	75	
Operation Range (Outdoor Temperature)	Cooling	Min. - Max.	°CDB (*FDB)	-5 - 54 (23.0 - 129.2)	-5 - 54 (23.0 - 129.2)

**TROPICAL COOL**

Nominal Capacity		RT	15	17.5	20	25	
Model Name		-	AK-Q1808C01	AK-Q2108C01	AK-Q2408C01	AK-Q3008C01	
Cooling Capacity	Net Capacity	kW	52.8	61.5	70.6	80.9	
		kcal/h	45,360	52,919	60,700	69,600	
		Btu/h	180,000	210,000	241,000	276,000	
	Gross Capacity	kW	54.2	64.2	73.6	85.0	
		Btu/h	185,100	219,000	251,100	290,000	
EER	Btu / Wh	11.6	12.8	11.6	10.5		
Power Input	Cooling	kW	15.50	16.40	20.70	26.20	
Power Supply		V, Ø, Hz	380-415, 3, 50	380-415, 3, 50	380-415, 3, 50	380-415, 3, 50	
Indoor Coil	Fin Type	-	LG Louver	LG Louver	LG Louver	LG Louver	
	Tube Size	Outer Dia.	mm (inch)	9.52 (3/8)	9.52 (3/8)	9.52 (3/8)	
	(Row × Column × Fins per inch) × No.	-	(3 × 24 × 16) × 2	(3 × 24 × 16) × 2	(3 × 24 × 16) × 2	(3 × 24 × 16) × 2	
	Face Area	m <sup>2</sup> (ft <sup>2</sup> )	2.18 (23.47)	2.18 (23.47)	2.18 (23.47)	2.18 (23.47)	
Indoor Fan	Type	-	Sirocco Fan	Sirocco Fan	Sirocco Fan	Sirocco Fan	
	Diameter	mm (inch)	450 (18)	450 (18)	450 (18)	450 (18)	
	Motor Output	Hp	5	5	5.0	7.5	
	Air Flow Rate	Nominal	m <sup>3</sup> /min	169.9	198.2	226.5	283.2
		Nominal	ft <sup>3</sup> /min	6,000	7,000	8,000	10,000
Drive type	-	Belt	Belt	Belt	Belt		
Compressor (#1, A Cycle)	Type	-	HSS DC SCROLL	HSS DC SCROLL	HSS DC SCROLL	HSS DC SCROLL	
	Motor Output	W × No.	4,200 × 1	5,300 × 1	5,300 × 1	5,300 × 1	
	Oil Type	-	FVC68D	FVC68D	FVC68D	FVC68D	
	Oil Charge	cc × No.	1,200 × 1	1,400 × 1	1,400 × 1	1,400 × 1	
Compressor (#2, B Cycle)	Type	-	HSS DC SCROLL	HSS DC SCROLL	HSS DC SCROLL	HSS DC SCROLL	
	Motor Output	W × No.	4,200 × 1	5,300 × 1	5,300 × 1	5,300 × 1	
	Oil Type	-	FVC68D	FVC68D	FVC68D	FVC68D	
	Oil Charge	cc × No.	1,200 × 1	1,400 × 1	1,400 × 1	1,400 × 1	
Outdoor Coil	Fin Type	-	Wide Louver Plus (Gold)	Wide Louver Plus(Gold)	Wide Louver Plus (Gold)	Wide Louver Plus(Gold)	
	Tube Size	Outer Dia.	mm (inch)	7 (9/32)	7 (9/32)	7 (9/32)	
	(Row × Column × Fins per inch) × No.	-	(2 × 42 × 14) × 4	(3 × 42 × 14) × 4	(3 × 42 × 14) × 4	(3 × 42 × 14) × 4	
	Face Area	m <sup>2</sup> (ft <sup>2</sup> )	7.06 (75.99)	7.06 (75.99)	7.06 (75.99)	7.06 (75.99)	
Outdoor Fan	Type	-	Propeller Fan	Propeller Fan	Propeller Fan	Propeller Fan	
	Diameter	mm (inch)	680 (26-25/32)	680 (26-25/32)	680 (26-25/32)	680 (26-25/32)	
	Motor Output	W × No.	900 × 4	900 × 4	900 × 4	900 × 4	
	Air Flow Rate	m <sup>3</sup> /min × No.	105 × 4	105 × 4	105 × 4	105 × 4	
		ft <sup>3</sup> /min × No.	3,700 × 4	3,700 × 4	3,700 × 4	3,700 × 4	
Drive	-	BLDC Inverter	BLDC Inverter	BLDC Inverter	BLDC Inverter		
Discharge Direction	-	Top	Top	Top	Top		
Dehumidification rate	ℓ/h	20.7	24.2	26.18	29.82		
Drain Connection Size	-	Male NPT 1	Male NPT 1	Male NPT 1	Male NPT 1		
Refrigerant	Refrigerant name	-	R410A	R410A	R410A	R410A	
	Precharged Amount	A-Circuit	kg	9.0	12.0	12.0	12.0
		B-Circuit	kg	9.0	12.0	12.0	12.0
	Control	-	Electronic Expansion Valve	Electronic Expansion Valve	Electronic Expansion Valve	Electronic Expansion Valve	
Dimensions (W × H × D)	mm		2,230 × 1,242 × 3,520	2,230 × 1,242 × 3,520	2,230 × 1,242 × 3,520	2,230 × 1,242 × 3,520	
	inch		87-25/32×48-29/32×138-19/32	87-25/32×48-29/32×138-19/32	87-25/32×48-29/32×138-19/32	87-25/32×48-29/32×138-19/32	
Net Weight	kg (lbs)		880 (1,940)	950 (2,094)	950 (2,094)	950 (2,094)	
Sound pressure levels	Cooling	dB (A)	85	85	85	85	
Operation Range (Outdoor Temperature)	Cooling	Min. - Max.	°CDB (*FDB)	-5 - 54 (23.0-129.2)	-5 - 54 (23.0-129.2)	-5 - 54 (23.0-129.2)	-5 - 54 (23.0-129.2)

# LG CONTROL SOLUTIONS

LG HVAC offers a diverse range of effective control solutions that satisfy specific needs of each building and its user scene. These controlling systems are equipped with user friendly interface, flexible interlocking environment, energy management and smart individual controller for optimized controlling conditions and smart building management.

## HOTEL

Hotel Room Solution



## OFFICE

### Central Control Solution

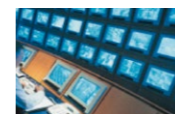

3<sup>rd</sup> Party BMS



Cloud System

### Energy Management



### External Device

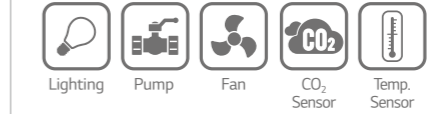

## APARTMENT

### Power Distribution Solution



## RESIDENTIAL

### Smart Individual Control Solution



## SMALL BUILDING







### Small Central Control Solution



# INDIVIDUAL CONTROL



## FEATURE FUNCTIONS

Controller Name	Wired Remote Controller					Wireless Remote Controller	Wi-Fi Controller
	Premium	Standard III	Standard II	Simple	Simple(Hotel)		
Model Name							
	PREMTA000 PREMTA000A PREMTA000B	PREMTB100 PREMTBB10	PREMTB001 PREMTBB01	PQRCVCLQ PQRCVCLQW	PQRCHA0Q PQRCHA0QW	<b>NEW</b> PWLSSB21H (H/P) PWLSSB21C (C/O)	PWFMD200
Basic	On / Off	○	○	○	○	○	○
	Fan Speed Control	○	○	○	○	○	○
	Temperature Setting	○	○	○	○	○	○
	Mode Change	○	○	○	○	-	○
	Auto Swing	○	○	○	○	○	○
	Vane Control (Louver Angle)	○	○	○	○	○	○
	ESP (External Static Pressure)	○	○	○	○	○	-
	Electric Failure Compensation	○	○	○	○	○	-
	Indoor Temperature Display	○	○	○	○	○	○
	ALL Button Lock (Child Lock)	○	○	○	○	○	-
Advanced	Schedule / Timer	Weekly-Yearly	Weekly-Yearly	Weekly	-	-	Sleep / On / Off Weekly
	Additional Mode Setting <sup>1)</sup>	○	○	○	-	-	-
	Time Display	○	○	○	-	-	○
	Humid. Display	○	○	-	-	-	-
	Advanced Lock (Mode, Set point, Set point range, On / Off Lock)	Advanced Lock	Advanced Lock	-	-	-	-
	Filter Sign	○	○	○	-	-	-
	Energy Management <sup>2)</sup>	○	○	○	-	-	-
	Dual Set Point	○	○	-	-	-	-
	Human Detection	-	○	-	-	-	-
	Temp., Humidity Compensation	○	○	-	-	-	-
Wi-Fi AP Mode Setting	○	○	○	○	○	○	
ETC	Operation Status LED	○	○	○	○	○	-
	Wireless Remote Controller Receiver	○ <sup>3)</sup>	-	○ <sup>3)</sup>	○ <sup>3)</sup>	○ <sup>3)</sup>	-
	Display	5 inch Color	4.3 inch Color	4.3 inch mono	2.6 inch mono	2.6 inch mono	2 inch mono
	Size (W x H x D, mm)	137 x 121 x 16.5	120 x 120 x 16	120 x 120 x 16	64 x 120 x 15	64 x 120 x 15	51 x 153 x 26
Black Light Control for Screen Saver	○	○	-	-	-	-	

※ ○ : Applied, - : Not Applied  
 1) It might not be indicated or operated at the partial product.  
 2) Centralized control (PACEZA000 / PACS5A000 / PACP5A000 / PLNWK000) and PDI (PQNUD1S40 / PPWRDB000) should be installed for this function.  
 3) For ceiling type duct  
 Note : 1. Indoor unit should have functions requested by the controller.  
 2. If you need more detail, please refer to the manual of product. (<http://partner.lge.com: Home > Doc.Library > Manual>)

# INDIVIDUAL CONTROL

## 3<sup>rd</sup> STANDARD WIRED REMOTE CONTROLLER

### Features & Benefit

4.3 inch Color screen with a modern design.



PREMTB100 (White)    PREMTBB10 (Black)

- The optimized controller for MULTI V 5
  - Humidity sensor embedded
  - Comfort cooling setting
  - Smart Load Control setting
  - Outdoor unit low noise setting
  - Defrost mode setting
- New modern design & easy interface
  - Seamless design / Touch button
  - 4.3 inch color LCD / Intuitive GUI
- Energy saving functions
  - Instantaneous power monitor
  - Energy consumption check (Power consumption, Operation time)
  - Temp. Setback timer, time limit control
  - Target setting (ODU capacity, Instantaneous power...etc)
- Group control
  - Up to 16 Indoor units can be controlled with one remote control
- External device On / Off (1 point)
  - Customized interlocking control with indoor unit is possible without dry contact
- 2 set points control
  - Increase convenience and comfort
  - Auto changeover, Setback (Home leave)

Model Name	PREMTB100 / PREMTBB10
On / Off	○
Fan Speed Control	○
Temperature Setting	○
Mode Change	Cooling / Heating / Auto / Dehumidification / Fan
Additional Mode Setting <sup>1)</sup>	Energy-Saving Cooling / Robot Cleaning / Heater / Humidification / Comfort Cooling
Auto Swing	○
Vane Control (Louver direction)	○
E.S.P (External Static Pressure) <sup>2)</sup>	○
Reservation	Simple / Sleep / On & Off Timer / Weekly / Yearly / Holiday
Time Display	○
Electric Failure Compensation	○
Lock	All / On & Off / Mode / Set Temperature Range
Filter Sign	○ (Remain time + Alarm)
Energy Management	Check Energy Usage <sup>3)</sup> / Check Operation Time / Target Setting (Energy, Operation Time) / Time Limit Operation / Alarm Popup / Initialization Usage Data
Operation Status LED	○
Indoor Temperature Display	○
Indoor Humidity Display	○
Human Detection	○
Display	4.3 inch TFT color LCD (480 x 272)
Size (W x H x D, mm)	120 x 120 x 16
Black light for Screen saver	○
Home Leave	2 set points control

※ ○ : Applied, - : Not Applied  
 1) It might not be indicated or operated at the partial product.  
 2) This function is available for duct type.  
 3) This function requires PDI (PQNUD1S40 / PPWRDB000) to be installed.  
 Note : 1. Indoor unit needs to have functions requested by the controller.  
 2. 2 set points control works normally with MULTI V Heat Recovery and Single Split Heat Pump. But in case of MULTI V Heat Pump, it may not work properly.

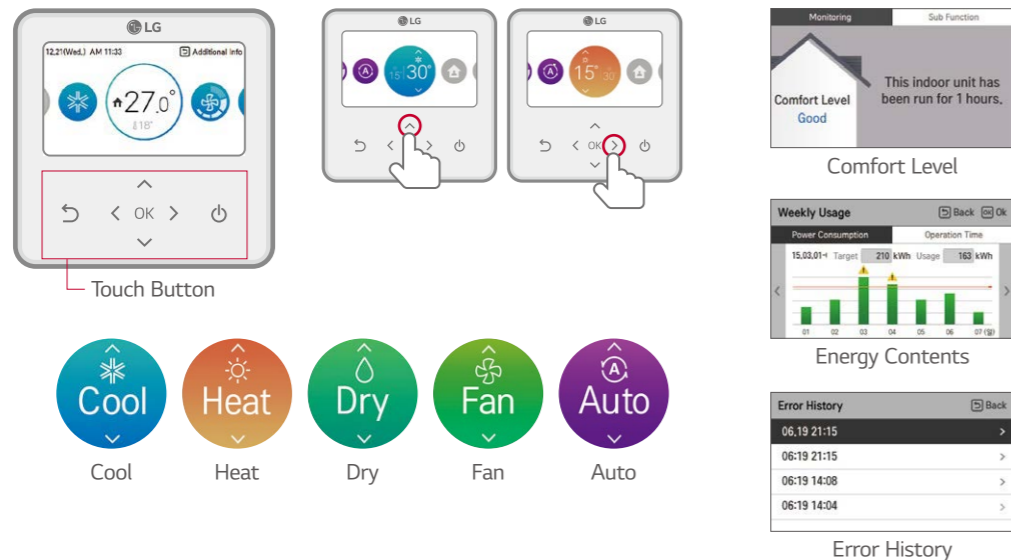

## Energy Saving Function

### Energy Management

- Energy Monitoring & Alarm  
 Real-time and day / week / month / year energy usage monitoring is possible. In addition, it can set target for energy usage and operation time, and alarm will be displayed when exceeded.

※ PDI (PQNUD1S40 / PPWRDB000) is required.

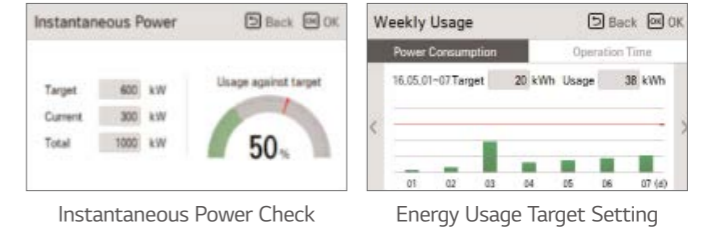

Instantaneous Power Check

Energy Usage Target Setting

### Time Limit Control

- The time-limit operation controls product by amount of time. By setting the device operation time in advance, you can control for how long a device works and have it stop automatically.



## 2 Set Points Control

### Auto Changeover (Convenience)

- The indoor unit automatically manages room temperature with heating and cooling with extended setting temperature ranges. With setting heating and cooling set temp. just one time, comfortable condition will continue at all times.

### Setback (Home Leave) (Energy saving & Comfort)

- In the absence, room temperature can be kept in the range of 2 set points instead of power off. It provides comfortable indoor environment quickly when the mode is changed to occupied.

※ This function is for Heat Recovery system or Single heat pump. Otherwise it is not guaranteed.

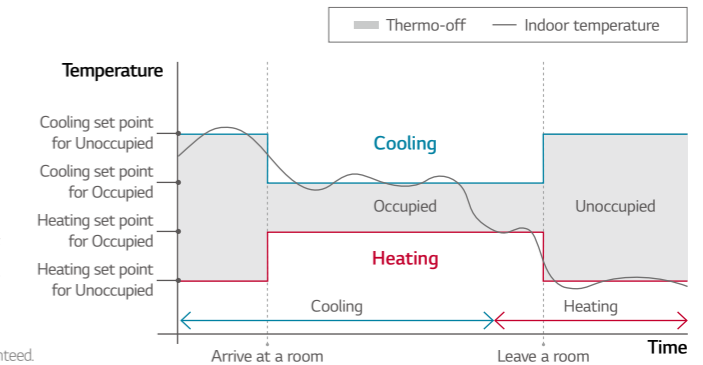

## External Device On / Off

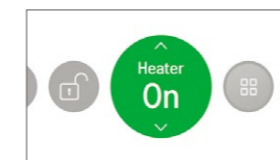

External Equipment Control  
 User can turn on or off the external equipment through contact point output.

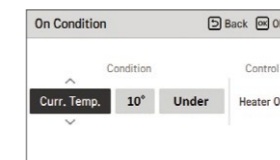

Customized Interlocking Control  
 User can make control scenario. For example when temperature is under 10 degree, turn on the external heater.

## Schedule Function



Easy Checking Schedule  
 Standard III remote controller provides clock type daily schedule.

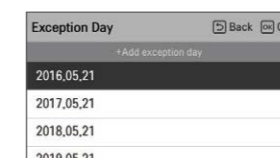

Exception Day Settings  
 Possible to set up exceptional date on regular schedule.

# INDIVIDUAL CONTROL

## PREMIUM WIRED REMOTE CONTROLLER

### Features & Benefit

5 inch full touch screen with a premium design.



PREMTA000 <sup>1)</sup> / PREMTA000A <sup>2)</sup> / PREMTA000B <sup>3)</sup>

- 1) English / Portuguese / Spanish / French
- 2) English / Italian / Russian / Chinese
- 3) English / German / Polish / Czech

- Full Touch screen
- The Optimized Controller in MULTI V 5
  - Comfort cooling setting
  - Smart Load Control setting
  - Outdoor unit low noise setting
  - Defrost mode setting
- Design with User's Convenience
  - Intuitive GUI
  - Main display simple mode
  - 5 inch color LCD
- Energy Saving Functions
  - Instantaneous power monitor
  - Energy consumption check (Power consumption, Operation time)
  - Temp. Setback Timer, Time Limit Control
  - Target setting (ODU Capacity, Instantaneous power... etc)
- Group Control
  - Up to 16 Indoor units can be controlled with one remote control
- 2 Set Points Control
  - Increase convenience and comfort
  - Auto changeover, Setback (Home leave)

Model Name	PREMTA000 / PREMTA000A / PREMTA000B
On / Off	○
Fan Speed Control	○
Temperature Setting	○
Mode Change	Cooling / Heating / Auto / Dehumidification / Fan
Additional Mode Setting <sup>1)</sup>	Energy-Saving Cooling / Robot Cleaning / Heater / Humidification
Auto Swing	○
Vane Control (Louver direction)	○
E.S.P (External Static Pressure) <sup>2)</sup>	○
Reservation	Simple / Sleep / On / Off / Weekly / Yearly / Holiday
Time Display	○
Electric Failure Compensation	○
Child Lock	○
Filter Sign	○ (Remain time + Alarm)
Energy Management	Check Energy Usage <sup>3)</sup> / Check Operation Time / Target Setting (Energy, Operation Time) / Time Limit Operation / Alarm Popup / Initialization Usage Data
Operation Status LED	○
Indoor Temperature Display	○
Wireless Remote Controller Receiver	○ <sup>4)</sup>
Display	5 inch TFT color LCD (480 x 272)
Size (W x H x D, mm)	137 x 121 x 16.5
Black Light for Screen Saver	○
Home Leave	2 set points control

※ ○ : Applied, - : Not Applied  
 1) It might not be indicated or operated at the partial product.  
 2) This function is available for duct type.  
 3) This function requires PDI (PQNUD1S40 / PPWRDB000) to be installed.  
 4) For ceiling type ducted unit.  
 Note : 1. Indoor unit needs to have functions requested by the controller.  
 2. 2 set points control works normally with MULTI V Heat Recovery and Single Split Heat Pump. But in case of MULTI V Heat Pump, it may not work properly.



Full Touch Screen

### Easy Energy Management

- Check the operation hour or electricity usage
- Comparison of usage compared to last year
- Set the target usage and time



### Easy Scheduling

- Daily, Weekly, Yearly schedule function
- Schedule pattern setting
- Schedule copy



### 2 Set points Control

- Auto changeover switching the operation mode automatically
- Setback (Home Leave) Changing status by occupied / unoccupied
- ※ This function is only for Heat Recovery system and Single heat pump.

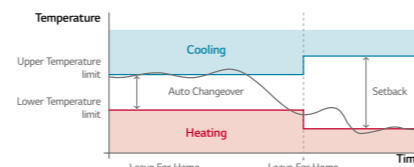

### Group Control

- Max. 16 Indoor units by one remote controller.

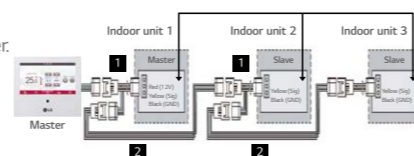

## 2<sup>nd</sup> STANDARD WIRED REMOTE CONTROLLER

### Features & Benefit

Providing easy control of one or a group of indoor units with various functions.



PREMTB001 (White)



PREMTBB01 (Black)

- Wired remote controller that can implement various functions such as schedule, filter sign.

Model Name	PREMTB001 / PREMTBB01
On / Off	○
Fan Speed Control	○
Temperature Setting	○
Mode Change	Cooling / Heating / Auto / Dehumidification / Fan
Additional Mode Setting	Energy-Saving Cooling / Robot Cleaning / Heater / Humidification
Auto Swing	○
Vane Control (Louver direction)	○
E.S.P (External Static Pressure)	○
Reservation	Simple / Sleep / On / Off / Weekly / Holiday
Time Display	○
Electric Failure Compensation	○
Child Lock	○
Filter Sign	○ (Remain time + Alarm)
Operation Status LED	○
Indoor Temperature Display	○
Wireless Remote Controller Receiver	○ <sup>1)</sup>
Size (W x H x D, mm)	120 x 120 x 16
Blacklight	○
Power Consumption Monitoring	○ <sup>2)</sup>
Check Model Information	○

※ ○ : Applied, - : Not Applied  
 1) For ceiling type ducted unit.  
 2) This function requires PDI (PQNUD1S40 / PPWRDB000) to be installed.  
 Note : Indoor unit needs to have functions requested by the controller.

## SIMPLE WIRED REMOTE CONTROLLER

### Features & Benefit

A simple way to control office or hotel systems in a compact design



PQRCVCLQW (White) / PQRCVCLQ (Black)



PQRCHCA0QW (White) / PQRCHCA0Q (Black)

- Small remote control with minimal functionality.

Model Name	PQRCVCLQW / PQRCVCLQ	PQRCHCA0QW / PQRCHCA0Q
On / Off	○	○
Fan Speed Control	○	○
Temperature Setting	○	○
Mode Change	Cooling / Heating / Auto / Dehumidification / Fan	-
Auto Swing	○	○
Vane Control (Louver direction)	○	○
E.S.P (External Static Pressure)	○	○
Electric Failure Compensation	○	○
Child Lock	○	○
Indoor Temperature Display	○	○
Wireless Remote Controller Receiver	○ <sup>1)</sup>	○ <sup>1)</sup>
Size (W x H x D, mm)	70 x 121 x 16	70 x 121 x 16
Blacklight	○	○

※ ○ : Applied, - : Not Applied  
 1) For ceiling type ducted unit.  
 Note : Indoor unit needs to have functions requested by the controller.

## WIRELESS REMOTE CONTROLLER

### Features & Benefit



NEW PWLSSB21H (H/P)  
 NEW PWLSSB21C (C/O)

- Easy to use while moving.
- Main functions are available.

Model Name	PWLSSB21H (H/P) / PWLSSB21C (C/O)
On / Off	○
Fan Speed Control	○ <sup>1)</sup>
Temperature Setting	○
Mode Change	Cooling / Heating / Auto / Dehumidification / Fan
Additional Mode Setting	Plasma Purification / Energy-Saving Cooling / Robot Cleaning / Auto Dry
Auto Swing	○
Vane Control (Louver direction)	○
Reservation	Sleep / On / Off
Time Display	○
Indoor Temperature Display	○
Sleep Mode Auto	Max. 7 hours
Size (W x H x D, mm)	51.4 x 153 x 26

※ ○ : Applied, - : Not Applied  
 1) For some products, you can use "slow" fan speed function.

# LG HVAC CONTROL LINE-UP

INDIVIDUAL CONTROL		CENTRALIZED CONTROL			
Wired Remote Controller		Wireless Remote Controller	Display	Platform	Gateway
Standard	Simple				
<b>Standard III (White)</b>  PREMTB100	 PQRCVCLQW	  NEW PWLSSB21H (H/P) NEW PWLSSB21C (C/O)	<b>AC Ez</b>  PQCSZ250S0 (Indoor Unit -32)	<b>ACP 5</b>  PACP5A000 (Indoor Unit -256) BACnet IP/Modbus TCP Gateway	<b>ACP LonWorks</b>  PLNWKB000 (Indoor Unit -64)
		<b>Wi-Fi Controller</b>			
<b>Standard III (Black)</b>  PREMTBB10	 PQRCVCL0Q	<b>LG Wi-Fi Modem</b>  For Indoor Unit PWFMD200	<b>AC Ez Touch</b>  PACEZA000 (Indoor Unit -64)	<b>AC Manager 5</b>  PACM5A000 (Indoor Unit -8,192)	<b>Modbus RTU Gateway</b>  PMBUSB00A
<b>Standard II (White)</b>  PREMTB001	 PQRCHCAQW (Simple for Hotel)		<b>AC Smart 5</b>  PACS5A000 (Indoor Unit -128) BACnet IP/Modbus TCP Gateway		<b>PI-485</b>  For Indoor Unit (ERV) PHNFP14A0
<b>Standard II (Black)</b>  PREMTBB01	 PQRCHCA0Q (Simple for Hotel)				
<b>Premium</b>					
 PREMTA000 PREMTA000A PREMTA000B					

CENTRALIZED CONTROL	INTEGRATION DEVICE			
Facility Integrator	Indoor Units		Outdoor Units	AHU Kit
	Dry Contact	Control Accessory		
<b>PDI (Power Distribution Indicator)</b>  Premium (8 port) PQNUD1S40 Standard (2 port) PPWRDB000	 Simple Dry Contact PDRYCB000	<b>Group Control Wire</b>  PZCWRG3	<b>IO Module (Input / Output Module)</b>  For MULTI V 5 PVDSMN000	<b>Communication Kit</b>  Return / Room Air control PAHCMR000
<b>ACS IO Module (Input / Output Module)</b>  PEXPMB000	 Dry Contact for Thermostat PDRYCB300	<b>Remote Temperature Sensor</b>  PQRSTA0	<b>Variable Water Flow Control kit</b>  For MULTI V WATER IV PWFCN000	 Discharge / Supply Air control PAHCS000
<b>Chiller Option Kit</b>  PCHLLN000	 Dry contact for Thermostat (For using universal input) NEW PDRYCB320	<b>Low Profile Remote Temperature Button Sensor</b>  ZRTBS01	<b>Low Ambient Kit</b>  For MULTI V IV, 5 PRVC2	<b>Controller Module</b>  Main Module NEW PAHCHMM000
<b>ACU IO Module</b>  UJO PEXPMB300	 2 Points Dry Contact (For Setback) PDRYCB400	<b>Zone Controller</b>  4 Zones by thermostat ABZCA	<b>Cool / Heat Selector</b>  PRDSBM	 Communication Module NEW PAHCMC000
 UO PEXPMB200	 For Modbus PDRYCB500		<b>Water Communication Module</b>  NEW PAHCMW000	<b>Control kit</b>  NEW PAHCNM000 (Max. 3 Outdoor Units)
 UI PEXPMB100			<b>EEV Kit</b>  PRLK048A0 (~ 28 kW)  PRLK096A0 (~ 56 kW)	
			 NEW PRLK396A0 (~ 112 kW)	
			 NEW PRLK594A0 (~ 168 kW)	

Note  
 1. AC Smart 5 & ACP 5 provides BACnet IP / Modbus TCP. 2. KNX Gateway is provided by INTESIS.  
 3. If you need more detail, please refer to the manual of product(or BECON PDB) (<http://partner.lge.com/global/index.lge>, Home→DocLibrary→Product →Control(BECON))